

ShipMo3D Version 3.0 User Manual for Creating Ship Models

Kevin McTaggart

Defence R&D Canada – Atlantic

Technical Memorandum

DRDC Atlantic TM 2011-307

December 2011

Principal Author

Kevin McTaggart

Approved by

Neil Pegg
Head, Warship Performance

Approved for release by

Calvin Hyatt
Chair/Document Review Panel

© Her Majesty the Queen in Right of Canada as represented by the Minister of National Defence, 2011

© Sa Majesté la Reine (en droit du Canada), telle que représentée par le ministre de la Défense nationale, 2011

Abstract

ShipMo3D is an object-oriented library with associated user applications for predicting ship motions in calm water and in waves. This report serves as a user manual for creating ship models using ShipMo3D Version 3.0. A companion report serves as a user manual for predicting ship motions in the time and frequency domains. Version 3 of ShipMo3D introduces modelling of sloshing tanks and U-tube tanks. Several ShipMo3D applications are used for creating a ship. SM3DPanelHull creates a panelled representation of the wet and dry portions of the ship hull. SM3DRadDif computes radiation and diffraction forces acting on the wet hull using a boundary element method. SM3DPanelSloshTank creates a panelled representation of a sloshing tank, such as a tank containing liquid cargo or a roll stabilization tank. SM3DRadSloshTank computes sloshing forces arising from motions in the frequency domain. SM3DBuildShip creates a model of the ship that can be used for ship motion predictions in either the frequency domain or time domain.

Résumé

ShipMo3D est une bibliothèque objet avec applications utilisateur connexes pour la prévision des mouvements de navires dans le domaine temporel et le domaine fréquentiel en eau calme et dans les vagues. Le présent rapport sert de manuel de l'utilisateur pour créer des modèles de navire à l'aide de la version 3.0 du logiciel ShipMo3D. Un rapport d'accompagnement sert également de manuel de l'utilisateur pour prévoir les mouvements de navires dans le domaine temporel et le domaine fréquentiel. La version 3.0 du logiciel ShipMo3D introduit la modélisation du ballonnement en citerne et de citernes à tube en U. Plusieurs applications du logiciel ShipMo3D sont utilisées pour créer un navire. L'application SM3DPanelHull crée une représentation en panneaux des parties humides et sèches de la coque du navire. L'application SM3DRadDif calcule le rayonnement et les forces de diffraction agissant sur la coque humide en utilisant une méthode à éléments de contour. L'application SM3DPanelSloshTank crée une représentation en panneaux d'une citerne à ballonnement, comme une citerne contenant une cargaison liquide ou une citerne antiroulis. L'application SM3DRadSloshTank calcule les forces de ballonnement créées par les mouvements, dans le domaine fréquentiel. L'application SM3DBuildShip crée un modèle de navire pouvant être utilisé pour prévoir les mouvements de navires soit dans le domaine fréquentiel ou le domaine temporel.

This page intentionally left blank.

Executive summary

ShipMo3D Version 3.0 User Manual for Creating Ship Models

Kevin McTaggart; DRDC Atlantic TM 2011-307; Defence R&D Canada – Atlantic; December 2011.

Introduction: Ship motions influence the performance and safety of naval personnel and systems. Consequently, ship motion predictions are often used to support ship design and operation. Frequency domain predictions are computationally efficient and suitable for ships travelling with steady speed and heading in moderate seaways. Time domain analysis is required to model motions if a ship is freely maneuvering or in a heavy seaway.

Principal Results: ShipMo3D is an object-oriented library with associated user applications for predicting ship motions in calm water and in waves. Motion predictions are available in both the frequency domain and the time domain. For predictions in the time domain, the ship can be freely maneuvering in either calm water or in waves. This report serves as a user manual for creating ship models using Version 3. A companion report provides a user manual for predicting ship motions in the time and frequency domains using created ship models. ShipMo3D Version 3 introduces capabilities for modelling U-tube tanks and sloshing tanks.

Significance of Results: ShipMo3D continues to be suitable for providing predictions of ship motions in waves. These simulations can be used for various applications, including engineering analysis, operations analysis, and training.

Future Plans: ShipMo3D Version 3 will be incorporated into simulations modelling naval platform systems using the High Level Architecture.

Sommaire

ShipMo3D Version 3.0 User Manual for Creating Ship Models

Kevin McTaggart ; DRDC Atlantic TM 2011-307 ; R & D pour la défense Canada – Atlantique ; décembre 2011.

Introduction : Les mouvements de navires ont une influence sur le rendement et la sécurité du personnel et des systèmes navals. Par conséquent, les prévisions des mouvements de navires sont souvent utilisées en appui à la conception et à l'exploitation des navires. Les prévisions du domaine fréquentiel sont efficaces pour l'évaluation et conviennent aux navires qui naviguent à vitesse continue et font cap dans des voies maritimes moyennement occupées. L'analyse du domaine temporel est requise pour modéliser les mouvements si un navire manœuvre librement ou dans une voie maritime très occupée.

Résultats principaux : ShipMo3D est une bibliothèque objet avec applications utilisateur connexes permettant de prévoir les mouvements de navires en eau calme et dans les vagues. Les prévisions des mouvements sont disponibles dans le domaine fréquentiel et dans le domaine temporel. Pour les prévisions dans le domaine temporel, le navire peut manœuvrer librement en eau calme ou dans les vagues. Le présent rapport sert de manuel de l'utilisateur pour la création de modèles de navires en utilisant la version 3. Un rapport d'accompagnement fournit un manuel de l'utilisateur pour les prévisions des mouvements de navires dans le domaine temporel et dans le domaine fréquentiel, en utilisant des modèles de navires déjà créés. La version 3 du logiciel ShipMo3D introduit des capacités permettant de modéliser des citernes à tube en U et des citernes à ballonnement.

Importance des résultats : ShipMo3D convient toujours pour la prévision des mouvements de navires dans les vagues. Les simulations peuvent être utilisées pour différentes applications, y compris l'analyse technique, l'analyse des opérations et la formation.

Travaux ultérieurs prévus : La version 3 du logiciel ShipMo3D sera intégrée à des simulations modélisant des systèmes de plate formes navales à l'aide de l'architecture de haut niveau.

Table of contents

Abstract	i
Résumé	i
Executive summary	iii
Sommaire	iv
Table of contents	v
List of tables	viii
List of figures	ix
1 Introduction	1
2 New Features for ShipMo3D Version 3	1
2.1 High Frequency Approximation for Evaluating Retardation Functions	2
2.2 Modelling of U-tube Tanks for Roll Stabilization	2
2.3 Modelling of Sloshing in Tanks with Free Surfaces	2
2.4 Application SM3DSeakeepSeawayFromRaos for Predicting Motions in a Seaway Using Input Response Amplitude Operators	3
2.5 Prediction of Motion Sickness Incidence in the Frequency Domain .	3
2.6 Output of Motion Response Amplitude Operators for Operability Analysis Using SHIPOP2	3
3 Overview of Using ShipMo3D for Creating a Model of a Ship for Predicting Motions	4
4 Coordinate Systems	7
5 Panelling of the Ship Hull – SM3DPanelHull	10
5.1 Hull Description Using a Patch Hull File	11
5.2 Control of Panelling of the Hull	15
6 Radiation and Diffraction Computations – SM3DRadDif	17
DRDC Atlantic TM 2011-307	v

7	Panelling of a Sloshing Tank – SM3DPanelSloshTank	20
8	Radiation Computations for a Sloshing Tank – SM3DRadSloshTank	23
9	Building of Ship Model – SM3DBuildShip	26
9.1	Hull Viscous Forces	28
9.2	Hull Maneuvering Forces	28
9.3	Ship Appendages – Bilge Keels, Static Foils, Skegs, and Rudders	29
9.4	Propellers (Non-azimuthing)	31
9.5	Rudder-Propeller Interaction Coefficients	32
9.6	Azimuthing Propellers	32
9.7	U-tube Tanks and Sloshing Tanks	34
9.8	Computation of Ship Propeller RPM for Specified Ship Speeds	34
10	Conclusions	38
	References	39
	Symbols and Abbreviations	42
	Annex A: Files for Panelling the Hull with SM3DPanelHull3	47
	A.1 Format of Input File for SM3DPanelHull3	47
	A.2 Format of Input PatchHull File	62
	A.3 Sample Input File for SM3DPanelHull3	66
	A.4 Sample Patch Hull Input File for SM3DPanelHull3	67
	A.5 Sample Output File for SM3DPanelHull3	77
	Annex B: Files for Radiation and Diffraction Computations with SM3DRadDif3	83
	B.1 Format of Input Radiation and Diffraction File for SM3DRadDif3	83
	B.2 Sample Input File for SM3DRadDif3	96
	B.3 Sample Output File for SM3DRadDif3	97

Annex C: Files for Panelling a Sloshing Tank with SM3DPanelSloshTank3 . . .	109
C.1 Format of Input File for SM3DPanelSloshTank3	109
C.2 Format of Input PatchSloshTank File	124
C.3 Sample Input File for SM3DPanelSloshTank3	128
C.4 Sample Patch Tank Input File for SM3DPanelSloshTank3 . . .	129
C.5 Sample Output File for SM3DPanelSloshTank3	131
Annex D: Files for Sloshing Tank Radiation Computations with SM3DRadSloshTank3	137
D.1 Format of Input Sloshing Tank Radiation File for SM3DRadSloshTank3	137
D.2 Sample Input File for SM3DRadSloshTank3	149
D.3 Sample Output File for SM3DRadSloshTank3	150
Annex E: Files for Building Ship with SM3DBuildShip3	161
E.1 Format of Input Ship File for SM3DBuildShip3	161
E.2 Sample Input File for SM3DBuildShip3	220
E.3 Sample Output File for SM3DBuildShip3	223
Document Control Data	233

List of tables

Table 1:	Command Line Options for ShipMo3D Applications	6
Table 2:	SM3DPanelHull Summary	10
Table 3:	Guidelines for Ordering of Offsets and Hull Lines for Different Hull Portions	13
Table 4:	SM3DRadDif Summary	17
Table 5:	SM3DPanelSloshTank Summary	20
Table 6:	SM3DRadSloshTank Summary	23
Table 7:	SM3DBuildShip Summary	26

List of figures

Figure 1:	Earth-Fixed Coordinate System	8
Figure 2:	Translating Earth Coordinate System	8
Figure 3:	Sea Direction Relative to Ship	9
Figure 4:	Panelled Wet Hull of Generic Frigate	10
Figure 5:	Patch Hull Lines of Generic Frigate	12
Figure 6:	Patch Hull Surfaces of Generic Frigate	12
Figure 7:	Hull Line within Patch Hull File, View from Aft	13
Figure 8:	Profile of Patch Representing the Main Portion of Ship Hull, View from Port Side	14
Figure 9:	Convention for Evaluating Hull Normal from Input Patch Data	14
Figure 10:	Ship Vertical Coordinates, View from Starboard	15
Figure 11:	Heave Added Mass and Damping for Generic Frigate	18
Figure 12:	Dimensions of Sloshing Tank with Rectangular Cross-Section	21
Figure 13:	Sloshing Tank with a Narrow Middle	22
Figure 14:	Sway Sloshing Added Mass and Damping for Box with Length of 4 m, Width of 4 m, and Fluid Height of 2 m	24
Figure 15:	Panelled Hull, Appendages, and Propellers of Generic Frigate from SM3DBuildShip	27
Figure 16:	Appendage Root Location and Dihedral Angle, View from Aft	30
Figure 17:	Dimensions for Static Foil or Rudder from Viewpoint Perpendicular to Appendage	30
Figure 18:	Thrust and Normal Forces Acting on an Azimuthing Propeller in Incident Flow	33
Figure 19:	Thrust Force Coefficient for Example Azimuthing Propeller	35

Figure 20: Normal Force Coefficient for Example Azimuthing Propeller . . .	35
Figure 21: Aft View of U-tube Tank with Fluid Displacement Angle	36
Figure 22: Aft View with ShipMo3D Input Dimensions for U-tube Tank . . .	37

1 Introduction

This report describes the creation of ship models for ShipMo3D Version 3.0, an object-oriented library with associated applications for simulation of a ship in waves. A companion report [1] is the user manual for predicting motions in the time and frequency domains using ShipMo3D Version 3.0. For each ShipMo3D application, user input is read from an ASCII input file. Each application produces an ASCII output file, and many applications also produce graphical output. The ShipMo3D graphical user interface (GUI), ShipMo3D30.exe, can be used to interactively prepare input data, launch applications, and view output results.

Several reports describe the theory behind ShipMo3D, and also give verification and validation of ShipMo3D results. References 2 and 3 describe the prediction of hull hydrodynamic forces. The modelling of seaways is described in Reference 4. Reference 5 covers appendage and viscous forces, which are important for predicting lateral plane motions. The extension of ShipMo3D to freely maneuvering ships is described in Reference 6, with refinements to maneuvering forces given in Reference 7. ShipMo3D Version 3.0 introduces modelling of U-tube tanks [8] and sloshing in tanks with free surfaces [9]. Reference 10 gives validation results for Version 3.0 of ShipMo3D.

Section 2 of this report describes features that are new for Version 3 of ShipMo3D. Section 3 gives an overview of creating ship models that can subsequently be used for motion predictions. Section 4 describes coordinate systems used for motions and ship geometry. Sections 5, 6, 7, 8, and 9 describe the ShipMo3D applications SM3DPanelHull, SM3DRadDif, SM3DPanelSloshTank, SM3DRadSloshTank, and SM3DBuildShip, which are used to build models of the ship hull geometry, hull radiation and diffraction properties, sloshing tank geometry, sloshing tank radiation properties, and ship including appendages. Final conclusions are given in Section 10. Annexes at the end of the report give input file descriptions and sample input and output files for the ShipMo3D applications.

2 New Features for ShipMo3D Version 3

ShipMo3D Version 3 supercedes Version 2 [11, 12]. Version 3 includes several major enhancements, and also has many minor code improvements.

2.1 High Frequency Approximation for Evaluating Retardation Functions

When computing wave radiation damping forces in the time domain, retardation functions are used [3]. The retardation functions are computed from wave radiation damping coefficients evaluated in the frequency domain. ShipMo3D Version 3 uses the following high frequency approximation for damping coefficients when computing retardation functions within SM3DBuildShip:

$$B_{ij}(\omega_e) = B_{ij}(\omega_e^*) \exp(-2\omega_e/\omega_e^* + 2) \text{ for } \omega_e \geq \omega_e^* \quad (1)$$

where B_{ij} is frequency domain damping for motion modes i and j , ω_e is wave encounter frequency, and ω_e^* is the highest encounter frequency for damping coefficients used for computing retardation functions. The above approximation helps to eliminate oscillatory behaviour of retardation functions at the maximum frequency ω_e^* .

The following high frequency approximation from Nam et al. [13] was originally considered for implementation in ShipMo3D:

$$B_{ij}(\omega_e) = B_{ij}(\omega_e^*) \left(\frac{\omega_e^*}{\omega_e} \right)^2 \text{ for } \omega_e \geq \omega_e^* \quad (2)$$

Equation (1) provides faster decay of damping coefficients at higher frequencies, and appears to give better modelling of actual behaviour. Note that Equations (1) and (2) give similar behaviour of the variation of damping coefficients with encounter frequency when encounter frequency ω_e is approximately equal to the maximum frequency ω_e^* .

2.2 Modelling of U-tube Tanks for Roll Stabilization

ShipMo3D can now model U-tube tanks for roll stabilization. Hydrodynamic forces are evaluated using the method of Lloyd [14], with ShipMo3D implementation described in Reference 8. Dimensions for U-tube tanks are given as input to SM3D-BuildShip.

2.3 Modelling of Sloshing in Tanks with Free Surfaces

ShipMo3D can now model sloshing in tanks with free surfaces. Examples of such tanks are cargo tanks and flume tanks for roll stabilization. SM3DPanelSloshTank builds a panelled representation of a sloshing tank. SM3DRadSloshTank computes sloshing hydrodynamic forces in the frequency domain based on the approaches of Malenica et al. [15] and Newman [16], with the ShipMo3D implementation described in Reference 9. Output sloshing tank data from SM3DRadSloshTank can be used as input to SM3DBuildShip when building ship models.

2.4 Application SM3DSeakeepSeawayFromRaos for Predicting Motions in a Seaway Using Input Response Amplitude Operators

The new application SM3DSeakeepSeawayFromRaos [1] can predict motions in the frequency domain for a ship travelling in a seaway defined in earth-fixed axes. SM3DSeakeepSeawayFromRaos reads pre-computed motion response amplitude operators (RAOs) which can be computed by SM3DSeakeepRandom. SM3DSeakeepSeawayFromRaos runs faster than SM3DSeakeepSeaway [1], and is suitable for applications such as real-time operator guidance.

2.5 Prediction of Motion Sickness Incidence in the Frequency Domain

When predicting ship motions in the frequency domain, the applications SM3DSeakeepRandom, SM3DSeakeepSeaway, and SM3DSeakeepSeawayFromRaos can now predict motion sickness incidence. Colwell [17] describes the approaches used for evaluating motion sickness incidence.

2.6 Output of Motion Response Amplitude Operators for Operability Analysis Using SHIPOP2

The frequency domain application SM3DSeakeepRandom [1] can now write motion response amplitude operators in SHIPMO7 ASCII post-processing format, which can be used as input for operability analysis using SHIPOP2 [18].

3 Overview of Using ShipMo3D for Creating a Model of a Ship for Predicting Motions

The following applications can be used when creating a ShipMo3D model of a ship:

SM3DPanelHull: Develops a model of the hull surface represented using triangular and quadrilateral panels. Also computes hydrostatic properties for submerged portion of hull.

SM3DRadDif: Computes hydrodynamic added mass and radiation damping for ship hull. Also computes forces due to incident and diffracted waves.

SM3DPanelSloshTank: Develops a model of the the surface of a sloshing tank represented using triangular and quadrilateral panels.

SM3DRadSloshTank: Computes sloshing tank hydrodynamic added mass and radiation damping.

SM3DBuildShip: Builds a model of the ship including all components relevant to predicting ship motions.

ShipMo3D: The ShipMo3D graphical user interface (ShipMo3D30.exe for Version 3.0) can be used to prepare input data, launch the above applications, and view results.

SM3DPanelHull creates a panel representation of the wetted hull surface based on input hull surface coordinates and load condition data. SM3DPanelHull can optionally produce a panel representation of the dry hull surface, which is required for non-linear simulations that consider the variation of the ship wetted surface with time. Ship hydrostatics and parameters for panel checking are included in output from SM3DPanelHull. Section 5 describes SM3DPanelHull in greater detail.

The wet panelled hull produced by SM3DPanelHull is used as input for radiation and diffraction computations in SM3DRadDif. SM3DRadDif produces a database file that can be used for subsequent ship motion computations. The output from SM3DRadDif should ideally encompass all combinations of ship speed, wave heading, and wave frequency that a ship will encounter. Typical computations encompassing all relevant combinations can require 2-3 hours; however, once a radiation and diffraction database has been produced it can be used for simulations in a variety of conditions. Section 6 describes SM3DRadDif in greater detail.

SM3DPanelSloshTank creates a panel representation of the wetted surface of the interior of a tank containing fluid. Output from SM3DPanelSloshTank can be used

for subsequent sloshing force computations. Section 8 describes SM3DRadSloshTank in greater detail.

The wet panelled tank interior produced by SM3DPanelSloshTank is used as input for sloshing radiation computations in SM3DRadSloshTank. SM3DRadSloshTank produces a database file that can be used for subsequent ship motion computations. The output from SM3DRadSloshTank should ideally encompass the full range of encounter frequencies that will influence ship motions. SM3DRadSloshTank typically requires less than one hour to run. Section 8 describes SM3DRadSloshTank in greater detail.

SM3DBuildShip builds a model of a ship for ship motion computations. The radiation and diffraction database file produced by SM3DRadDif is a key input component to SM3DBuildShip. If the ship includes sloshing tanks, then one or more sloshing radiation database files produced by SM3DRadSloshTank can be given as inputs. Other program inputs include descriptions of appendages (bilge keels, rudders, foils, and skegs), propellers, U-tube tanks, and hull resistance. SM3DBuildShip can build a ship model for either simulation in the time domain or for predictions in the frequency domain using the applications described in Reference 1.

The above ShipMo3D applications use 3 main types of files. User input data are read from input files with names ending with “.inp”. Application output data for review by the user are written to output files with names ending with “.out”. Transfer of data between applications is typically done using files in .NET binary serialization format, with names ending with “.bin”. For files representing a seaway, .NET XML serialization format is used to facilitate utilization by other applications such as visualizers.

Each ShipMo3D application has default file names for input and output. Prefixes can be added to default file names by typing “-p PREFIX” as a command line option, where PREFIX is the specified file name prefix (e.g., the ship name). Alternatively, full input and output file names can be specified on the command line. Input file names can be specified by typing “-i INFILE” as a command line option, where INFILE is the specified input file name. Similarly, output file names can be specified by typing “-o OUTFILE” as a command line option, where OUTFILE is the specified output file name. The command line option “-h” shows any command line arguments associated with a ShipMo3D application. The command line option “-e” specifies that exceptions that occur during program execution should be fully written to the console. Table 1 summarizes command line options.

ShipMo3D user input files are in ASCII format. Each input line typically begins with a tag denoting the contents of the input line. Comments can be inserted into a file using the character “#” to denote a comment line or the beginning of a comment after other input on a line. An exclamation mark “!” denotes that an input line is

Table 1: *Command Line Options for ShipMo3D Applications*

-p PREFIX	Input and output file names have prefix PREFIX
-i INFILE	Input file name is INFILE
-o OUTFILE	Output file name is OUTFILE
-h	Help is written to output console
-e	Execution exceptions are written to console

continued on the next line. Here is some sample input demonstrating the usage of the comment and continuation characters:

```
# Sample input from a patch hull file.
begin hullLine
  station 0
  yOffsets  0.000  0.059  0.069  0.091  0.121  0.164  0.218  0.282 !
            0.357  0.440  0.532  0.633  0.740  0.857  0.981  1.113 !
            1.250  1.389  1.530  1.671  1.812  1.950  2.086  2.217 !
            2.342  2.509  2.633  2.739  2.751
  zOffsets  4.427  4.700  4.977  5.253  5.530  5.806  6.083  6.359 !
            6.636  6.912  7.189  7.465  7.742  8.018  8.295  8.571 !
            8.848  9.124  9.401  9.677  9.954 10.230 10.507 10.783 !
            11.060 11.462 11.793 12.125 12.166
end hullLine
```

ShipMo3D applications include capabilities for plotting various entities, such as a panelled hull geometry or results of radiation computations. These plots can be saved as images in png or jpg formats.

Detailed input formats and sample input and output files are given in Annexes A to E.

4 Coordinate Systems

ShipMo3D uses both earth-fixed and translating earth coordinate systems. Figure 1 shows a ship in an earth-fixed coordinate system. The location of the ship centre of gravity in the horizontal plane is given by x^f, y^f . The direction ν of incident waves is given using a “from” convention, with 0° representing waves from north and 90° representing waves from east. Ship heading χ is given using a “to” convention, with 0° representing the ship heading north and 90° representing the ship heading east.

A translating earth coordinate system, shown in Figure 2, is used for representing ship motions in heave, roll, and pitch, and also for frequency domain applications. Heave η_3 is the vertical displacement (+ upward) of the ship centre of gravity relative to its position when the ship is in calm water; thus, the mean heave is typically near zero. Ship pitch η_5 of a freely maneuvering ship is given relative to its position at heading χ , and ship roll η_4 is given relative to the instantaneous heading angle χ and pitch angle η_5 of the moving ship.

Wave diffraction computations using SM3DRadDif are based on relative sea direction β_s as shown in Figure 3 (180° for head seas, 90° for seas from port). Relative sea direction is related to ship heading and wave heading by:

$$\beta_s = \nu + 180^\circ - \chi \quad (3)$$

For deflections of rudders, ShipMo3D uses a convention of positive deflection when counter-clockwise as viewed from inside the hull. Consequently, positive deflection of a typical ship rudder pointing downward will cause a ship to turn starboard.

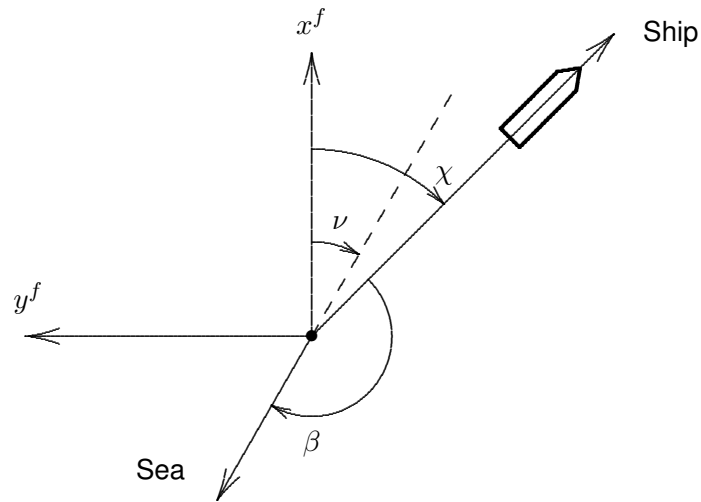

Figure 1: Earth-Fixed Coordinate System

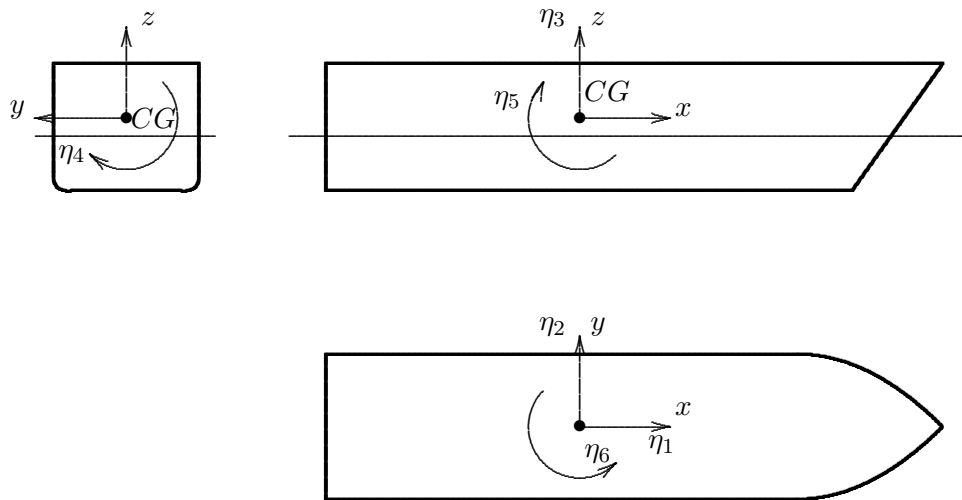

Figure 2: Translating Earth Coordinate System

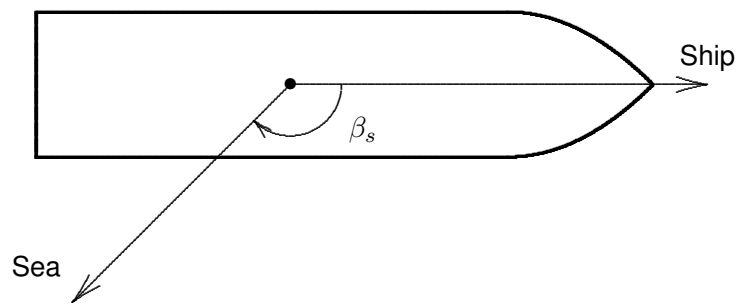

Figure 3: *Sea Direction Relative to Ship*

5 Panelling of the Ship Hull – SM3DPanelHull

Table 2 gives a summary of the application SM3DPanelHull. Figure 4 shows an example wet panel hull created by SM3DPanelHull. The panel colours indicate the elevation of the centroid of each panel relative to the waterline.

Table 2: *SM3DPanelHull Summary*

Purpose:	Creates a panel representation of the wet hull, and optionally of the dry hull.
Run time:	Several seconds.
Default input file:	panelHull3.inp
Default output file:	panelHull3.out
Sample files and file format:	Annex A
Other required input:	Patch hull file developed by user.

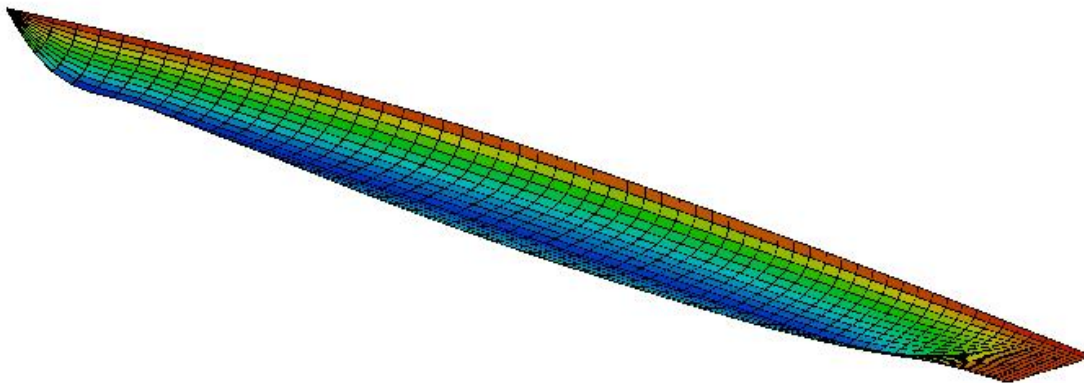

Figure 4: *Panelled Wet Hull of Generic Frigate*

Like all ShipMo3D applications, SM3DPanelHull reads user input from a file. The format of the main SM3DPanelHull input file is given in Annex A.1. SM3DPanelHull also reads data from a patch hull file, which has hull coordinate data. Annex A.2 describes the format of the patch hull file. The patch hull file is a reference description of the hull geometry, while the main input file is used to control how panels are generated to model the hull geometry. Ideally, the patch hull file only has to be developed once, and then can be left as a permanent representation of the hull. In

contrast, the main input file can vary depending on the ship loading condition and how the user wants the hull to be panelled.

5.1 Hull Description Using a Patch Hull File

The patch hull file models the hull as a series of patches, with a patch being a continuous surface. For example, an ellipsoid could be modelled by a single patch. As a more complex example, Figures 5 and 6 show the hull lines and fitted surfaces for the generic frigate used as an example for this report. The main portion of the hull is red, the deck is green, and the transom consists of blue and cyan portions.

Each patch is represented by a series of successive hull lines. A hull patch must have at least 2 hull lines. Each hull line must have at least 1 point. For example, a patch representing a bulbous bow could have a hull line with a single point at the front, followed by additional hull lines each having several points.

Figure 7 shows an example of a hull line on the main portion of the hull. The ship is assumed to be symmetric about the centreline; thus, offset points are only given for the port side of the hull. For a hull line intersecting the waterline, successive points should generally have increasing elevation. The hull line in Figure 7 can be described as follows in the patch hull file:

```
begin hullLine
  stations      8.0 8.0 8.0 8.0 8.0 8.0 8.0 8.0 8.0 8.0 8.0 8.0 8.0
  yOffsets      0.0 0.6 1.2 2.3 3.0 3.7 4.0 4.2 4.4 4.5 4.7 4.8 4.9
  zOffsets      0.3 0.4 0.5 0.8 1.1 1.5 1.9 2.3 2.9 3.5 4.3 5.4 6.5
end hullLine
```

The input record “stations” gives the station of each point on the hull line. Station 0 represents the fore perpendicular, and station 20 (or sometimes 10) typically represents the aft perpendicular. Note that the offsets on a hull line do not need to all have the same station. The input record “yOffsets” gives lateral offsets, which should all be ≥ 0.0 because only the port side of the hull is modelled. The input record “zOffsets” gives vertical offsets relative to the baseline. The baseline is a straight line, and typically represents the elevation of the keel for a substantial portion of a ship.

Figure 8 shows a profile of a hull patch representing the main portion of a ship hull. The patch consists of 6 hull lines, with the first hull line (index 0) representing the foremost point on the ship. For correct evaluation of hull surface normals, it is essential that hull lines be arranged in the direction indicated by Figure 9. To assist with correct panelling of the hull surface from patch data, user input for a patch

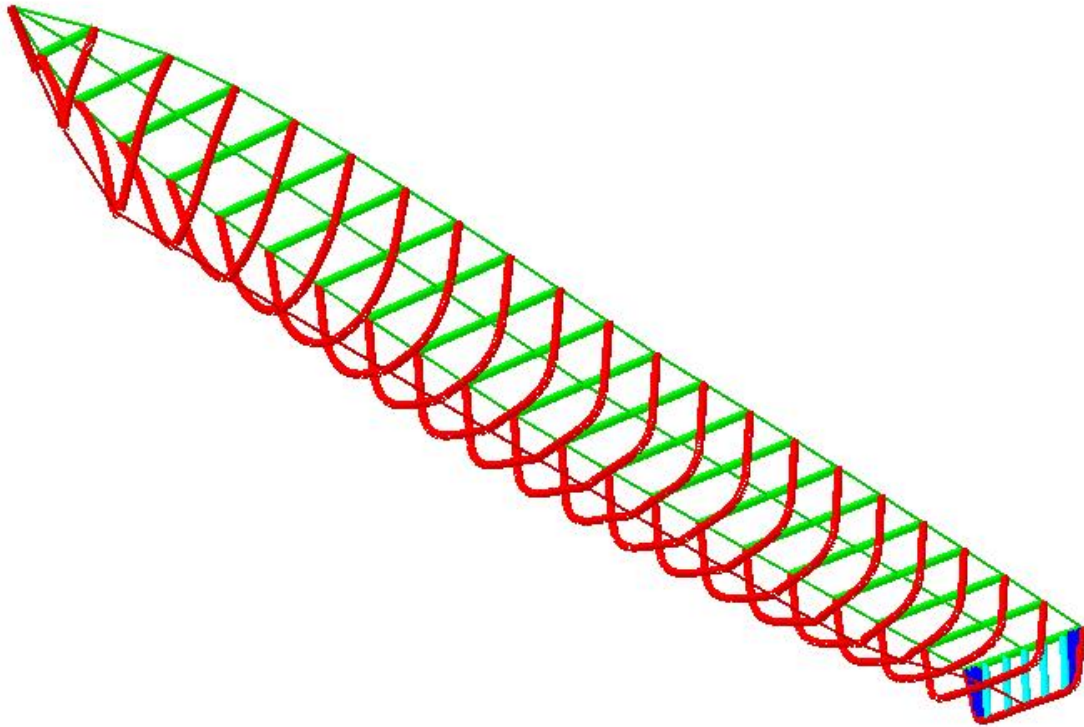

Figure 5: Patch Hull Lines of Generic Frigate

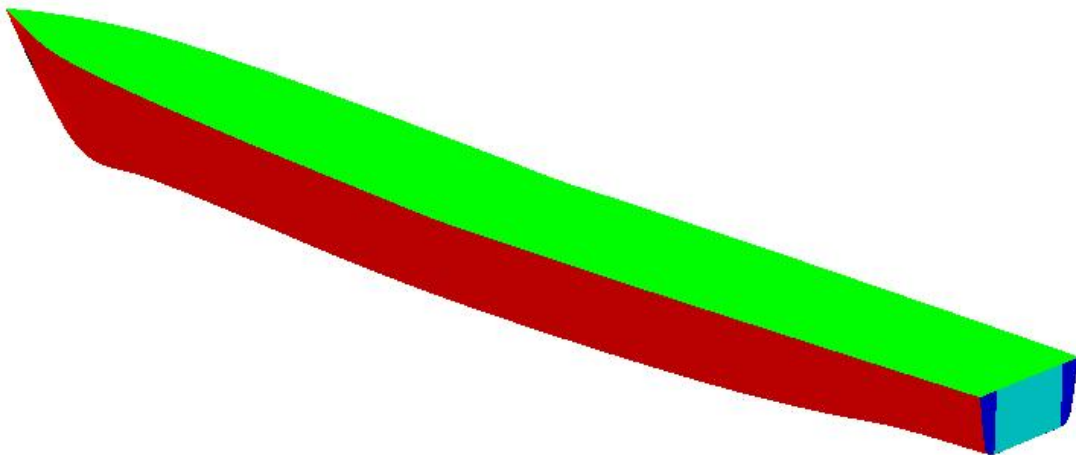

Figure 6: Patch Hull Surfaces of Generic Frigate

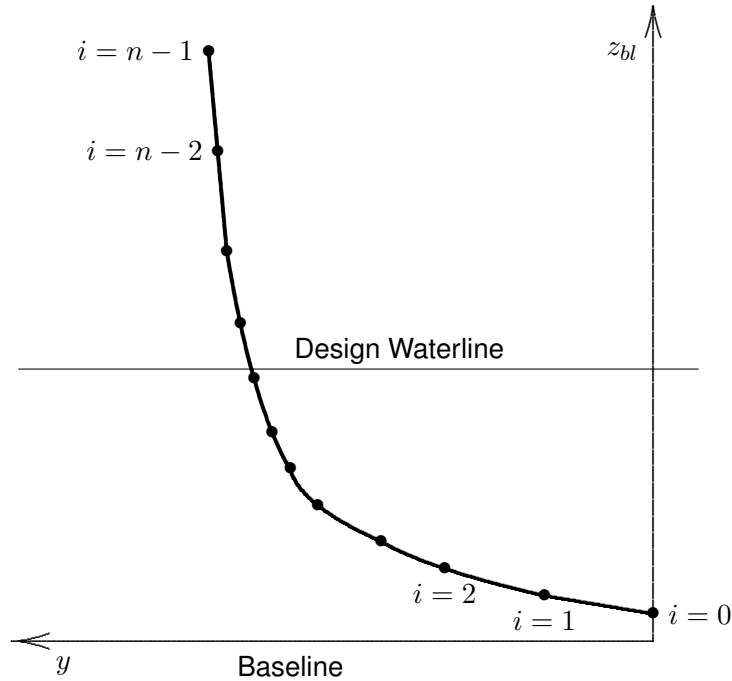

Figure 7: Hull Line within Patch Hull File, View from Aft

includes valid ranges of normal components. ShipMo3D uses a convention of hull normals pointing outward from the hull.

In summary, the following should be observed when creating a patch hull file:

- For non-horizontal hull lines, the order of offset points should go from lower to higher elevation.
- The order of successive hull lines must be given to satisfy the hull normal convention of Figure 9.

Table 3 gives guidelines for patch representations of different parts of a hull.

Table 3: Guidelines for Ordering of Offsets and Hull Lines for Different Hull Portions

Main hull surface	Offsets on a hull line go from keel to port deck edge. Successive hull lines go from bow to stern.
Deck	Offsets on a hull line go from port deck edge to centreline. Successive hull lines go from bow to stern.
Transom	Offsets on a hull line go from bottom to deck edge. Successive hull lines go from port edge to centreline.

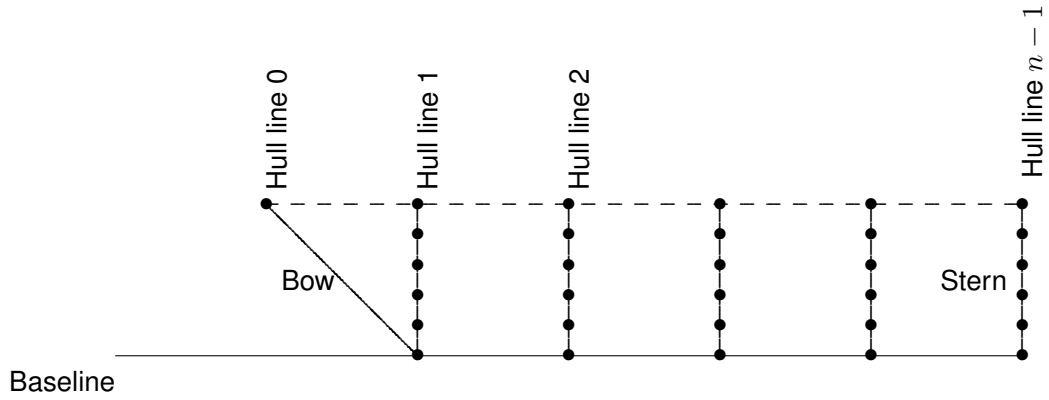

Figure 8: Profile of Patch Representing the Main Portion of Ship Hull, View from Port Side

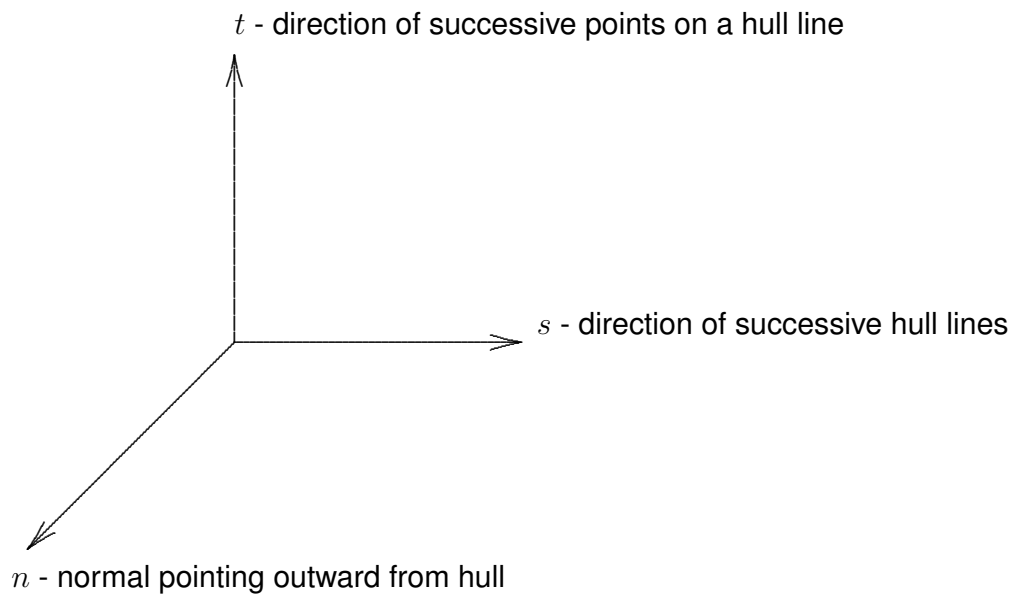

Figure 9: Convention for Evaluating Hull Normal from Input Patch Data

If the patch hull is going to be used to build both wet and dry panelled hulls, then the patch hull should represent a closed volume. If only a wet panelled hull will be built, then it is not necessary to enclose the dry portion of the hull.

Each input patch includes an optional input parameter to limit the maximum size of panels representing the patch. This parameter can be useful for portions of the hull surface with smaller curvature radii (e.g., bulbous bows) that require smaller panels than the remainder of the hull surface.

5.2 Control of Panelling of the Hull

The main input file for SM3DPanelHull controls panelling of the hull described by the patch hull file. SM3DPanelHull panels the wet hull, and optionally panels the dry hull. Figure 10 shows the ship vertical coordinates. When giving the input load condition, the user can provide one of the following sets of input data:

- draft of baseline at midships (draftBIMid) and trim of the baseline by the stern (trimBIStern),
- displacement of the ship (dispTonnesInput) and the longitudinal distance from the fore perpendicular to the the centre of gravity (distanceFPCGInput).

If the displacement and LCG are provided as input, then an iterative procedure is used to determine the combination of draft and trim that produces a wet panelled hull with the correct displacement and LCG.

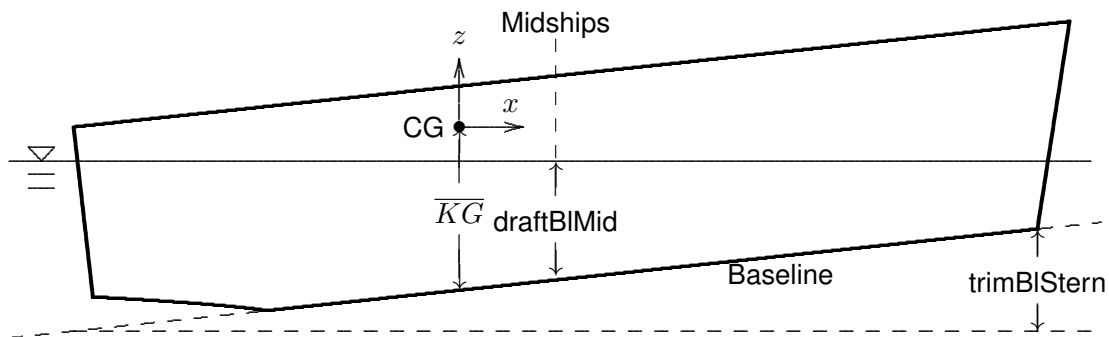

Figure 10: Ship Vertical Coordinates, View from Starboard

SM3DPanelHull fits smooth B-spline surfaces [19] to hull patches described by input hull lines. If difficulties are encountered with a fitted surface (e.g., a normal vector has unexpected direction or a y coordinate is less than zero) then these can often be

resolved by dividing the patch in the vicinity of a hull line where the difficulties are encountered.

The panel area limit `areaPanelLimit` is one of the most important input parameters for `SM3DPanelHull`. For typical ship geometries, it is recommended that `areaPanelLimit` be selected such that the wet portion of the hull surface is represented by 200-500 panels on the port side.

`SM3DPanelHull` can produce plots such as those given in Figures 4, 5, and 6. These plots are very useful for checking the quality of a hull model. For the plots of the patch hull surfaces and hull panels, the interior of the hull is black, which can be useful for checking that hull normals are oriented correctly.

The `SM3DPanelHull` output file gives values for checking the quality of the panelled hull mesh, such as normal ranges for hull patches. The output file also gives closure errors for the hull in the x and z directions, such as the following from the sample output file:

```
**** CHECK OF CLOSURE FOR COMBINED WET AND DRY HULL ****
```

```
Calculated properties for checking combined mesh of wet and dry hull
Closure error sum of area*nx      :      0.183245 m2
Closure error/approx front area    :      0.001146
Closure error sum of area*nz      :      0.100498 m2
Closure error/approx top area      :      0.000110
```

The non-dimensional closure errors should typically be less than 0.01.

6 Radiation and Diffraction Computations – SM3DRadDif

Table 4 gives a summary of the application SM3DRadDif, which computes hydrodynamic forces due to added mass, wave radiation damping, and wave excitation from incident and diffracted waves. Computations are performed in the frequency domain; however, results can be transformed to the time domain for subsequent computations. Due to the complexities of ship hydrodynamic computations, SM3DRadDif is considered to be the most computationally intensive of ShipMo3D applications. The approach used for computing hull hydrodynamic forces is described in detail in References 2 and 3.

Table 4: *SM3DRadDif Summary*

Purpose:	Creates a database of added mass, radiation damping, and wave excitation forces for the ship in all conditions to be encountered in subsequent motion computations.
Run time:	Several minutes without wave diffraction computations. Up to several hours with full wave diffraction computations.
Default input file:	radDif3.inp
Default output file:	radDif3.out
Sample files and file format:	Annex B
Other required input:	Wet panelled hull created by SM3DPanelHull.

SM3DRadDif computes hull added mass and radiation damping for a range of encounter frequencies specified by user input. Figure 11 shows computed added mass and damping for a naval frigate. The input encounter frequencies should be selected such that the variation of added mass and damping with encounter frequency is captured for all 6 degrees of freedom. The main output file from SM3DRadDif and optional plot files of hydrodynamic coefficients can be examined to determine whether a suitable range of encounter frequencies has been used. Both the output file and plot files give non-dimensional coefficients with magnitude relative to the ship inertia force amplitude during sinusoidal motion. At the highest encounter frequency, added mass should approach its infinite frequency value and damping should approach zero. For naval frigates, an encounter frequency range of 0.1, 0.2, . . . , 6.0 rad/s is suitable. Froude scaling can be applied to determine suitable encounter frequency ranges for

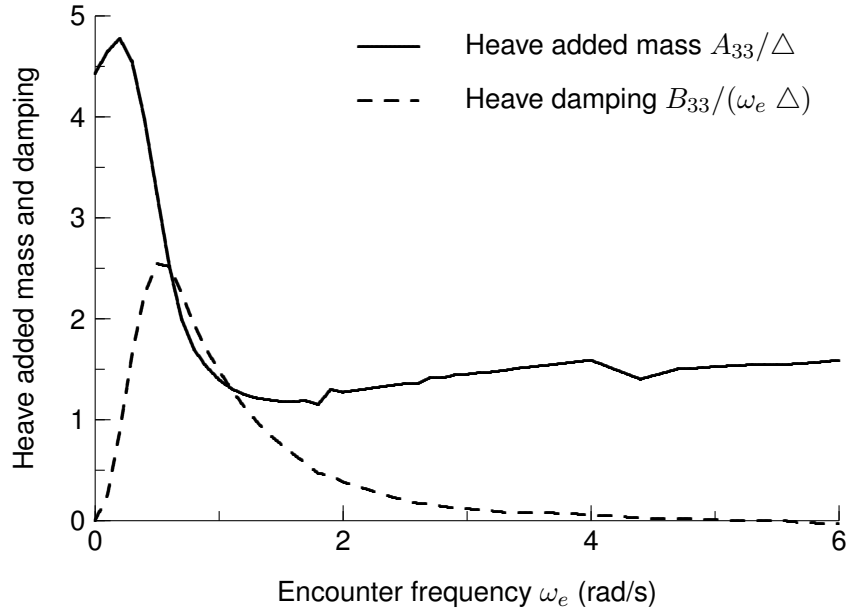

Figure 11: Heave Added Mass and Damping for Generic Frigate

ships of other sizes.

Like most hydrodynamic panel codes, SM3DRadDif will have irregular frequencies associated with each wet panel hull. An irregular frequency is a frequency at which the solution of hull source strengths and hull associated velocity potentials gives unreliable results. To better understand irregular frequencies, note that source strengths on the hull are solved by satisfying the following:

$$[D] \{\sigma\} = \left\{ \frac{\partial \phi}{\partial n} \right\} \quad (4)$$

where $[D]$ is the influence matrix giving hull normal velocity from source strengths, $\{\sigma\}$ is the vector of source strengths to be solved, and $\{\partial \phi / \partial n\}$ is the vector of known normal velocities on the hull surface. At irregular frequencies, the solution of source strengths $\{\sigma\}$ is highly sensitive to variations in elements of the influence matrix $[D]$. Variations in computed source strengths $\{\sigma\}$ will lead to variations in computed velocity potentials $\{\phi\}$, which are evaluated using the following:

$$\{\phi\} = [E] \{\sigma\} \quad (5)$$

where $[E]$ is the influence matrix giving velocity potential from source strength.

SM3DRadDif uses lateral symmetry when solving for hydrodynamic coefficients; thus, longitudinal modes have one set of irregular frequencies and lateral modes have another set of irregular frequencies. When examining plots of added mass and/or damping versus encounter frequency, large local variations occur at irregular frequencies.

Similarly, an irregular frequency will usually have a large local increase in the condition number of matrix $[D]$ from Equation (4). To prevent SM3DRadDif from using computations at irregular frequencies, user input can include threshold matrix condition numbers indicating the presence of irregular frequencies. The threshold matrix condition numbers can be determined by examining the results of an initial SM3DRadDif run.

The most time consuming part of running SM3DRadDif is usually the evaluation of wave diffraction forces. Note that wave diffraction forces should be evaluated for all combinations of ship speed, heading, and wave frequency that a ship is likely to encounter. For a naval frigate, an input ship speed range of 0, 5, 10, . . . , 40 knots can be used. Note that the upper speed should include the influence of wave-induced surge motion for a freely maneuvering ship. An input relative sea direction range of 0, 15, 30, . . . , 180 degrees is suitable for any ship. An input wave frequency range of 0.1, 0.2, 0.3, . . . , 2.0 rad/s usually is sufficient for the range of seaways encountered by full-scale ships.

SM3DRadDif includes an option for suppressing diffraction computations. The primary purpose of this option is to permit checking for irregular frequencies before proceeding with time-consuming diffraction computations. It is suggested that the following sequence be used when using SM3DRadDif for a new wet panel hull:

1. Run SM3DRadDif with diffraction computations suppressed.
2. Check output for irregular frequencies and re-run SM3DRadDif with appropriate thresholds on matrix condition numbers.
3. Check revised output for irregular frequencies. If irregular frequencies still exist, repeat step 2 with revised matrix condition numbers. If no irregular frequencies remain, then run SM3DRadDif including diffraction computations.

As indicated above, SM3DRadDif can produce plots of non-dimensional hydrodynamic coefficients and matrix condition numbers. These plots are very useful when checking for irregular frequencies.

7 Panelling of a Sloshing Tank – SM3DPanelSloshTank

Table 5 gives a summary of the application SM3DPanelSloshTank.

Table 5: *SM3DPanelSloshTank Summary*

Purpose:	Creates a panel representation of the interior of wet sloshing tank, and optionally of the dry sloshing tank.
Run time:	Several seconds.
Default input file:	panelSloshTank3.inp
Default output file:	panelSloshTank3.out
Sample files and file format:	Annex C
Other required input:	Patch sloshing tank exterior file developed by user. This file is only required if the sloshing tank has a complex shape.

Like all ShipMo3D applications, SM3DPanelSloshTank reads user input from a file. The format of the main SM3DPanelSloshTank input file is given in Annex C.1. Figure 12 shows dimensions for a simple sloshing tank with a rectangular cross-section. SM3DPanelSloshTank can easily model a box-shaped sloshing tank or a tank with a narrow middle (see Figure 13) using minimal input.

For modelling of more complex tank geometries, SM3DPanelSloshTank can read data for a patch representation of the tank, which is similar to the patch representation of a hull read by SM3DPanelHull. Annex C.2 describes the format of the patch sloshing tank file. To simplify creation of the patch sloshing tank input file, the file uses a geometric convention to specify the exterior of the sloshing tank (i.e., normal vectors point outward from the sloshing tank, which is the same convention as used for a patch hull file). SM3DPanelSloshTank then performs the required conversion to obtain the geometries of panels representing the interior of the tank.

Guidelines for panelling and the ship hull (see Section 5) are applicable to panelling of a sloshing tank. It is recommended that a minimum of 200 panels be used to model the wetted port side of a sloshing tank.

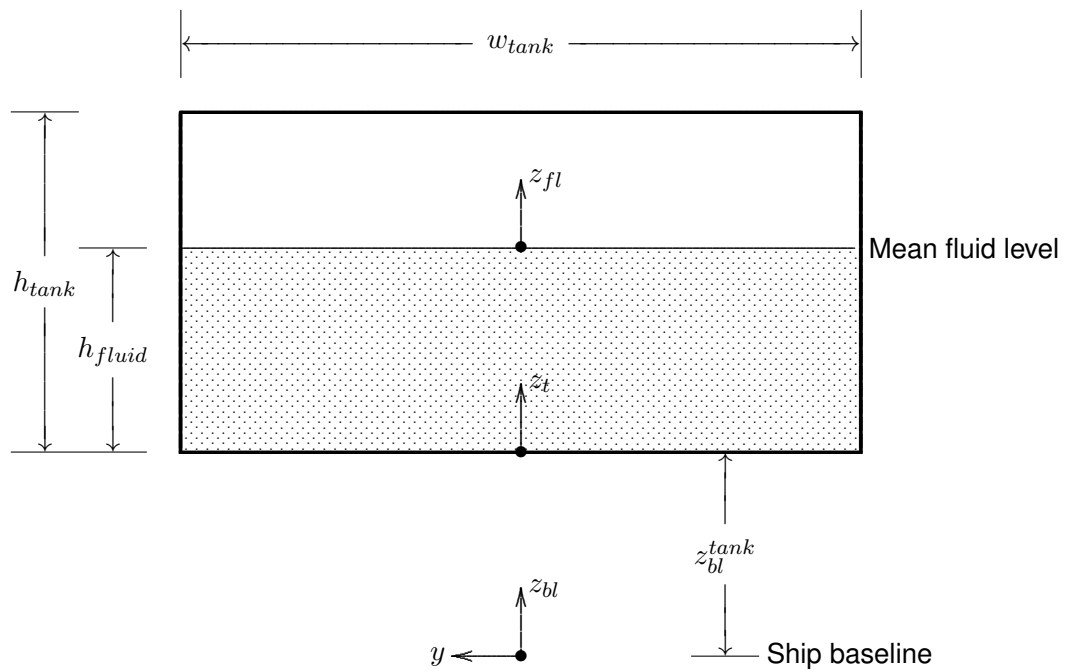

Figure 12: Dimensions of Sloshing Tank with Rectangular Cross-Section

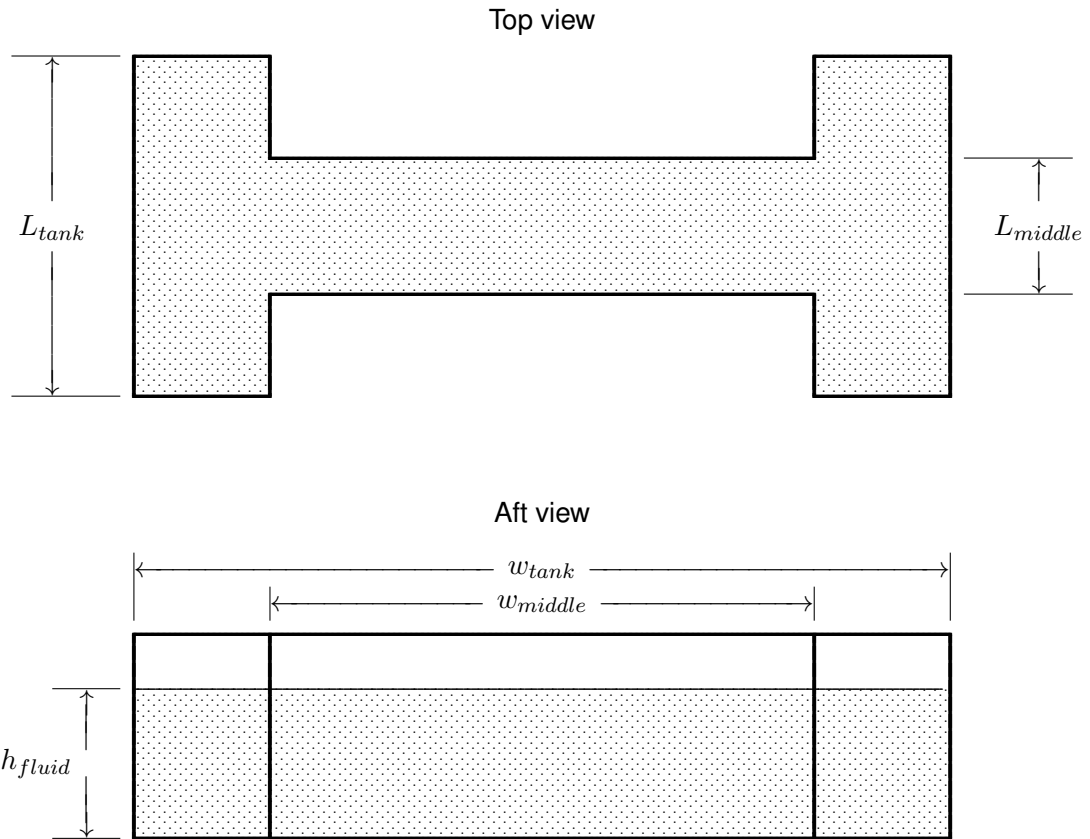

Figure 13: Sloshing Tank with a Narrow Middle

8 Radiation Computations for a Sloshing Tank – SM3DRadSloshTank

Table 6 gives a summary of the application SM3DRadSloshTank, which computes hydrodynamic forces acting on a sloshing tank due to added mass and wave radiation damping. Computations are performed in the frequency domain; however, results can be transformed to the time domain for subsequent computations. The approach used for computing sloshing hydrodynamic forces is described in detail in Reference 9.

Table 6: *SM3DRadSloshTank Summary*

Purpose:	Creates a database of added mass and radiation damping forces for a sloshing tank.
Run time:	Approximately 1 hour.
Default input file:	radSloshTank3.inp
Default output file:	radSloshTank3.out
Sample files and file format:	Annex D
Other required input:	Wet panelled sloshing tank created by SM3DPanelSloshTank.

SM3DRadSloshTank computes sloshing tank added mass and radiation damping for a range of encounter frequencies specified by user input. Figure 14 shows computed added mass and damping for a box with length of 4 m, width of 4 m, and fluid height of 2 m. The input encounter frequencies should be selected such that the variation of added mass and damping with encounter frequency is captured for sloshing modes that will influence the motions of the ship. When selecting the range of encounter frequencies, it can be useful to consider the following analytical solution for sloshing natural frequencies of a box of width w_{tank} subject to sway motion [20]:

$$\omega_n^{slosh} = \sqrt{g \lambda_n^{slosh} \tanh(\lambda_n h_{fluid})} \text{ for } n = 1, 2, \dots \quad (6)$$

$$\lambda_n^{slosh} = \frac{n \pi}{w_{tank}} \quad (7)$$

where n is the sloshing mode number. The sway sloshing added mass and damping coefficients for a box-shaped tank will typically vary significantly in the vicinity of sloshing frequencies for odd-numbered modes ($n = 1, 3, 5, \dots$). Computations suggest that $0.02 \omega_1^{slosh}$ is a suitable value for both the minimum encounter frequency and encounter frequency increment, and that $4 \omega_1^{slosh}$ is a suitable value for the maximum encounter frequency.

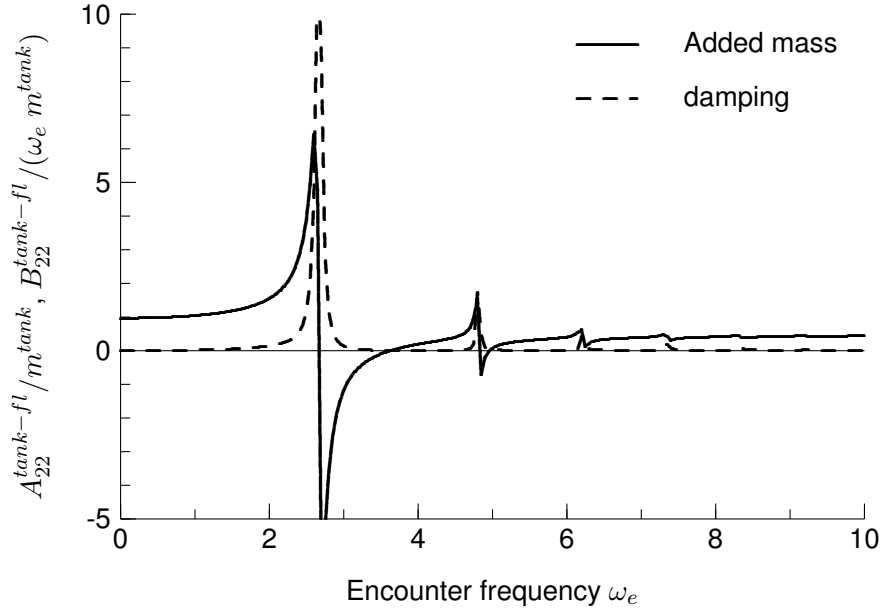

Figure 14: Sway Sloshing Added Mass and Damping for Box with Length of 4 m, Width of 4 m, and Fluid Height of 2 m

The main output file from SM3DRadSloshTank and optional plot files of hydrodynamic coefficients can be examined to determine whether a suitable range of encounter frequencies has been used. Both the output file and plot files give non-dimensional coefficients with magnitude relative to the static mass inertia force amplitude during sinusoidal motion.

An approach similar to that developed by Malenica et al. [15] is used to model viscous effects within a sloshing tank. The normal flow boundary condition on the wetted tank walls is modified to include an empirical damping factor ϵ_{tank} as follows:

$$\frac{\partial \phi_j^{slosh}}{\partial n} = i \omega_e n_j^{fl} + \frac{i \epsilon_{tank}}{\sqrt[3]{V_{fluid}}} \phi_j^{slosh} \text{ on } S_t \text{ for } j = 1 - 6 \quad (8)$$

where ϕ_j^{slosh} is sloshing potential in the frequency domain for ship motion mode j , n_j^{fl} is the normal vector pointing into the tank fluid, V_{fluid} is the volume of fluid in the tank, and S_t is the wetted interior tank surface. Viscous effects are likely to be insignificant at zero and infinite frequency limits; thus, the empirical damping factor is modelled to be dependent on frequency as follows:

$$\epsilon_{tank}(\omega_e) = \left(\frac{\omega_e}{\omega_{lower}^{\hat{\epsilon}}} \right)^2 \hat{\epsilon}_{tank} \text{ for } \omega_e \leq \omega_{lower}^{\hat{\epsilon}} \quad (9)$$

$$\epsilon_{tank}(\omega_e) = \left(\frac{\omega_{upper}^{\hat{\epsilon}}}{\omega_e} \right)^2 \hat{\epsilon}_{tank} \text{ for } \omega_{upper} > \omega_{upper}^{\hat{\epsilon}} \quad (10)$$

where $\hat{\epsilon}_{tank}$ is the peak value of the damping factor, which is applicable at frequencies ranging from $\omega_{lower}^{\hat{\epsilon}}$ to $\omega_{upper}^{\hat{\epsilon}}$. It is suggested that $\omega_{lower}^{\hat{\epsilon}}$ and $\omega_{upper}^{\hat{\epsilon}}$ be selected such that they encompass the main sloshing frequencies of the tank, which can be determined by examining the variation of added mass with frequency. For example, $\omega_{lower}^{\hat{\epsilon}}$ can be set to half of the first sloshing mode frequency and $\omega_{upper}^{\hat{\epsilon}}$ can be set to the maximum frequency used for sloshing computations.

Like SM3DRadDif, SM3DRadSloshTank can remove irregular frequencies caused by ill-conditioned solutions for sloshing velocity potentials; however, work to date suggests that irregular frequencies will typically not occur when solving sloshing velocity potentials.

Input for SM3DRadSloshTank includes the delay time increment $\Delta\tau$ and delay time maximum τ_{max} for sloshing retardation functions, which are used for ship motion computations in the frequency domain. Recommended values are $\Delta\tau = 0.25/\omega_1^{slosh}$ and $\tau_{max} = 120/\omega_1^{slosh}$. SM3DRadSloshTank includes an option for correcting sloshing retardation functions to account for the finite maximum delay time τ_{max} . It is recommended that this option be used, with care being taken to specify a sufficiently large number of τ_{max} to capture the essential behaviour of the retardation function.

The location of a sloshing tank on a ship is not specified as input for SM3DPanelSloshTank or SM3DRadSloshTank. Instead, the tank location is specified as input to SM3DBuildShip. This approach allows the tank location on the ship to be changed without re-running SM3DPanelSloshTank or SM3DRadSloshTank.

9 Building of Ship Model – SM3DBuildShip

Table 7 gives a summary of application SM3DBuildShip, which creates a database of all relevant ship properties used for computation of ship motions. Figure 15 shows a sample view of a hull and appendages produced by SM3DBuildShip. SM3DBuildShip can build ship models for simulation in the time domain or for predictions in the frequency domain.

Table 7: *SM3DBuildShip Summary*

Purpose:	Creates a database of ship properties influencing hydrodynamic forces, including hull radiation and diffraction, hull resistance, hull maneuvering, appendages, and propellers.
Run time:	Several seconds, or several minutes if propeller RPMs are to be determined for specified ship speeds.
Default input file:	buildShip3.inp
Default output file:	buildShip3.out
Sample files and file format:	Annex E
Other required input:	Hull radiation and diffraction database created by SM3DRadDif. Dry panel hull file if nonlinear buoyancy and incident wave forces will be used for ship motion predictions.

A dry panel hull file is among the optional input parameters for SM3DBuildShip. Note that this option must be used if ship motion predictions with SM3DFreeMo will include nonlinear buoyancy and incident wave forces.

SM3DBuildShip includes optional input for adjusting the metacentric height of the ship. This parameter can be set to a negative value to model the influence of partially filled tanks on roll stiffness. Note that such a correction for partially filled tanks is only required if they have not been explicitly modelled as U-tube tanks or sloshing tanks within ShipMo3D.

Input radii of gyration for roll, pitch, and yaw are given as values for the dry ship, and do not include the influence of ship added mass. Estimates of radii of gyration are as follows:

$$r_{44} \approx 0.4 B_{max} \quad (11)$$

$$r_{55} \approx 0.25 L \quad (12)$$

$$r_{66} \approx 0.25 L \quad (13)$$

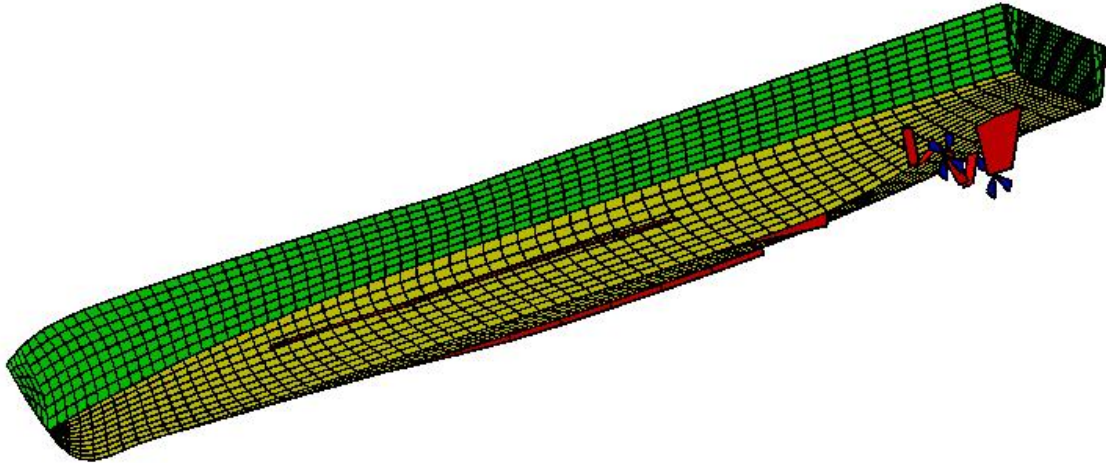

Figure 15: *Panelled Hull, Appendages, and Propellers of Generic Frigate from SM3DBuildShip*

where r_{44} is roll radius of gyration, r_{55} is pitch radius of gyration, and r_{66} is yaw radius of gyration. If the ship natural roll period is known but the ship roll gyradius is unknown, it is recommended that SM3DBuildShip be run with several different input gyradius values to determine which value produces the correct natural roll period.

For time domain predictions of ship motions, wave radiation forces are evaluated using retardation functions. The retardation functions are determined using transforms of wave radiation forces in the frequency domain. SM3DBuildShip reads input for the time interval and maximum value of retardation functions. The time interval should be sufficiently fine to capture the variation of retardation functions, and the maximum value should encompass the time when retardation functions approach zero. For a naval frigate, a time interval of 0.2 s and maximum time of 20 s provide good representation of retardation functions. Suitable values for other ships can be estimated using Froude scaling as follows:

$$\Delta\tau \approx 0.05\sqrt{\frac{L}{g}} \quad (14)$$

$$\tau_{max} \approx 5\sqrt{\frac{L}{g}} \quad (15)$$

where $\Delta\tau$ is the time interval and τ_{max} is the maximum time for retardation functions.

9.1 Hull Viscous Forces

Viscous hull force input is given in the form of hull resistance coefficients for various speeds, an eddy-making roll damping coefficient, and a lateral drag coefficient. References 5, 6 and 7 give further discussion of hull viscous forces. The hull resistance force is evaluated as follows:

$$F_1^{resist} = -\frac{1}{2} \rho U |U| A_w C_{Dx}(U) \quad (16)$$

where U is the ship speed, A_w is the wetted surface area, and C_{Dx} is the hull resistance coefficient.

Hull eddy-making damping at zero speed is evaluated by:

$$F_4^{hull-eddy} = -\frac{1}{2} \rho |\dot{\eta}_4| \eta_4 C_{eddy}^{hull} \frac{1}{2} \int_{S_{hull}} n_4^2 \sqrt{y^2 + z^2} dS \quad (17)$$

where C_{eddy}^{hull} is the hull eddy-making coefficient for roll, S_{hull} is the wetted hull surface, and n_4 is the roll normal. At non-zero speed, a speed correction factor is applied. The hull eddy-making coefficient has a default value of 1.17, the drag coefficient for a flat plate moving perpendicular to flow. Note that hull eddy-making damping is typically a small fraction of roll damping; thus, roll motion predictions are usually not very sensitive to the value of the hull eddy-making coefficient.

ShipMo3D can model hull cross-flow drag as follows:

$$F_2^{cross} = \frac{1}{2} \rho \sum_{i=1}^{N_{seg}} v^{cross}(\bar{x}_{Ay-i}) |v^{cross}(\bar{x}_{Ay-i})| A_{y-i} C_{Dy} \quad (18)$$

where N_{seg} is the number of longitudinal segments along the hull for evaluating cross-flow drag, v^{cross} is cross-flow velocity, \bar{x}_{Ay-i} is the x centroid of the profile area of segment i , A_{y-i} is the profile area of segment i , and C_{Dy} is the hull cross-flow drag coefficient. Within ShipMo3D, the hull cross-flow drag coefficient is often set to zero because cross-flow drag forces are instead modelled using nonlinear maneuvering coefficients. If nonlinear maneuvering coefficients are not used to model cross-flow drag, then the cross-flow drag coefficient can be set to a value of approximately 1.0.

9.2 Hull Maneuvering Forces

References 6 and 7 provide background information for prediction of hull maneuvering forces. The user can provide input hull maneuvering coefficients or can use values predicted based on the method of Inoue et al. [21]. As discussed in Reference 6, there is significant uncertainty associated with hull maneuvering coefficients and resulting

hull maneuvering predictions. Most notably, the uncertainty in the linear yaw-yaw coefficient N_r can lead to significant uncertainty in predicted ship turning circle characteristics. Consequently, it is recommended that the best possible estimates of hull maneuvering force coefficients be provided as input. If maneuvering force coefficients are unavailable but maneuvering trial data exist, then one can consider modifying the yaw-yaw coefficient N_r to obtain good agreement between observed and predicted turning circles.

9.3 Ship Appendages – Bilge Keels, Static Foils, Skegs, and Rudders

Ship appendages significantly influence ship motions in sway, roll, and yaw. SM3D-BuildShip currently models bilge keels, static foils (e.g., propeller shaft brackets), skegs, and rudders. If modelling of roll stabilizer fins is required, then these can be input as additional rudders. References 5 and 6 discuss treatment of appendage forces.

Bilge keels and skegs are considered to have long chord lengths, with input dimensions provided at several longitudinal locations along the hull. Static foils and rudders are considered to have short chord lengths, with input dimensions provided at only a single longitudinal location. Figure 16 shows an appendage attached to a hull. The convention for dihedral angle is 0° for the appendage pointing to port and 90° for the appendage point upward. Rudders and skegs typically have dihedral angles of -90° . Port bilge keels typically have dihedral angles of approximately -45° , and starboard bilge keels typically have dihedral angles of approximately -135° . Figure 17 shows dimensions for a static foil or rudder, where c_{root} is the root chord length, c_{tip} is the tip chord length, and s is the span.

When predicting lateral plane ship motions, one of the greatest challenges is accurate prediction of viscous roll damping from bilge keels. It is recommended that Ikeda's method [5] be used for predicting viscous bilge keel damping.

To simplify input and reduce the possibility of input errors, the user can specify that input is being given for a pair of appendages. The user then provides input data for only the port appendage. SM3DBuildShip then generates a port appendage first, and a starboard appendage second.

For rudders, SM3DBuildShip requires input autopilot data. The rudder response characteristics are modelled as follows:

$$\ddot{\delta}^{rudder} + 2 \zeta_\delta \omega_\delta^{rudder} \dot{\delta}^{rudder} + \omega_\delta^2 \delta^{rudder} = \omega_\delta^2 \delta_C^{rudder} \quad (19)$$

where $\ddot{\delta}^{rudder}$ is rudder acceleration, ζ_δ is the nondimensional damping response constant, ω_δ is the rudder response natural frequency, $\dot{\delta}^{rudder}$ is rudder velocity, and

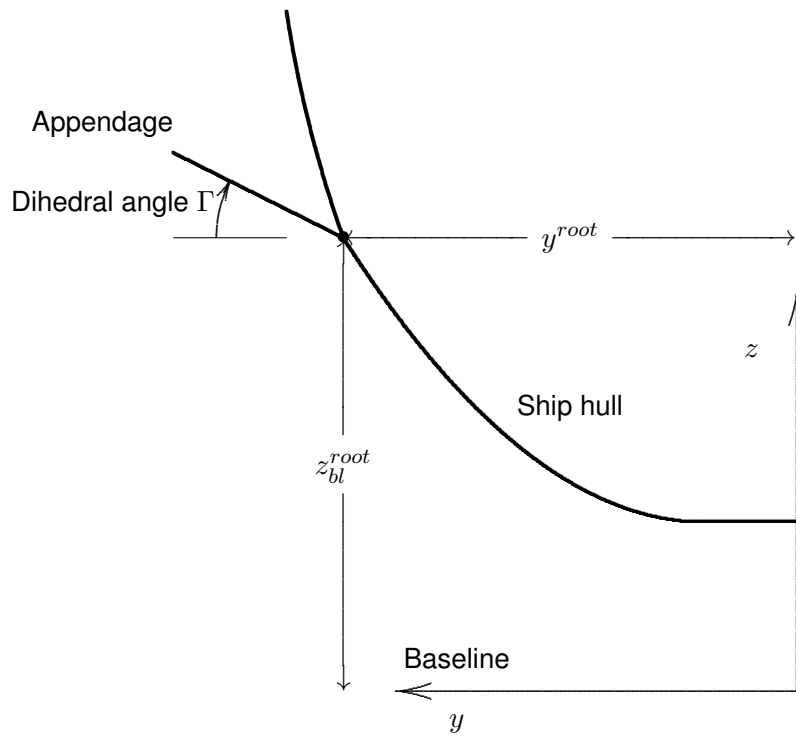

Figure 16: Appendage Root Location and Dihedral Angle, View from Aft

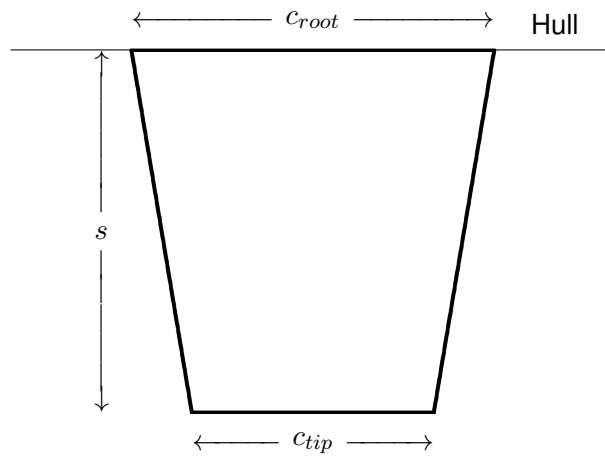

Figure 17: Dimensions for Static Foil or Rudder from Viewpoint Perpendicular to Appendage

δ_C^{rudder} is the command rudder angle. Rudder deflections have a convention of positive for counter-clockwise deflection viewed from inside the hull. If the rudder is operating in autopilot mode, then the rudder command angle is determined by input autopilot gains and ship motions in earth-fixed axes:

$$\delta_C^{rudder} = \sum_{j=1}^6 \left[k_{\delta_j}^P (\eta_j^f - \eta_{Cj}^f) + k_{\delta_j}^I \int_0^{\tau_{max}^{rudder}} (\eta_j^f(t - \tau) - \eta_{Cj}^f) d\tau + k_{\delta_j}^D \dot{\eta}_j^f \right] \quad (20)$$

where $k_{\delta_j}^P$ is the proportional gain for mode j , η_j^f is the motion displacement in earth-fixed axes for mode j , η_{Cj}^f is the command motion displacement for mode j , $k_{\delta_j}^I$ is the integral gain for mode j , τ_{max}^{rudder} is the integration duration, t is the current time, τ is the time delay for integration, $k_{\delta_j}^D$ is the derivative gain for mode j , and $\dot{\eta}_j^f$ is the motion velocity in earth-fixed axes for mode j . Within SM3DBuildShip, input autopilot gains should always be given in terms of earth-fixed axes.

The simulation of a rudder control system including autopilot requires selection of suitable input values. For a US Coast Guard cutter representative of modern frigate design, Smith [22] indicates a maximum rudder deflection of 35 degrees and maximum rudder rate of 3 degrees per second. For modelling of a conventional downward rudder using ShipMo3D, the autopilot yaw gain and yaw velocity gain for a freely maneuvering ship will typically have values less than or equal to zero.

The natural frequency of rudder control systems is often significantly greater than the natural frequencies for ship motion modes; thus, a smaller time step is often required for rudder motions than for ship motions during time domain simulations. The user can specify a maximum allowable time step for rudder motions to ensure reliable prediction of rudder motions.

9.4 Propellers (Non-azimuthing)

SM3DBuildShip can model fixed pitch propellers as described in Reference 6. The thrust created by the propeller is modelled as:

$$F^{prop} = (1 - t_{prop}) \rho n_{prop}^2 D_{prop}^4 K_T(J_{prop}) \quad (21)$$

where t_{prop} is the propeller thrust deduction coefficient, n_{prop} is the propeller speed in revolutions per second, and D_{prop} is the propeller diameter. The propeller thrust coefficient K_T is a function of the advance coefficient J_{prop} , which is given by:

$$J_{prop} = \frac{U (1 - w_{prop})}{n_{prop} D_{prop}} \quad (22)$$

where w_{prop} is the propeller wake fraction. The following quadratic function is used to model the relationship between propeller thrust coefficient K_T and advance coefficient

J_{prop} :

$$K_T = K_T^0 + K_T^J J_{prop} + K_T^{JJ} J_{prop}^2 \quad (23)$$

where K_T^0 , K_T^J , and K_T^{JJ} are specified coefficients. The user can provide K_T^0 , K_T^J , and K_T^{JJ} as input values, or these values can be computed based on 3 input pairs of J_{prop} and $K_T(J_{prop})$.

To simplify input and reduce the possibility of input errors, the user can specify that input is being given for a pair of propellers. The user then provides input data for only the port propeller. SM3DBuildShip then generates a port propeller first, and a starboard propeller second.

The propeller control system is modelled very similarly to the rudder control system, with the rate of change of propeller RPM being modelled as follows:

$$R\ddot{P}M^{prop} = \omega_{RPM}^2 (RPM_C^{prop} - RPM^{prop}) - 2\zeta_{RPM} \omega_{RPM} R\dot{P}M^{prop} \quad (24)$$

where $R\ddot{P}M^{prop}$ is the second derivative with respect to time of propeller RPM, ω_{RPM} is the RPM response natural frequency, RPM_C^{prop} is command propeller RPM, RPM^{prop} is propeller RPM, ζ_{RPM} is RPM response damping, and $R\dot{P}M^{prop}$ is the first derivative with respect to time of propeller RPM. The user can specify a maximum allowable time step for simulation of propeller RPM in a manner similar to that used for rudder deflection.

9.5 Rudder-Propeller Interaction Coefficients

For rudders placed aft of propellers, flow from propellers can significantly increase the effectiveness of the rudders. This effect is modelled using rudder-propeller interaction coefficients, as described in Reference 7, which supercedes the treatment presented in Reference 6. The rudder-propeller interaction coefficient represents the effective fraction of the rudder area that lies within the propeller slipstream. For a rudder immediately behind a propeller with the rudder locating entirely within the propeller slipstream, the rudder-propeller interaction coefficient will approach its limiting value of 1.0. If a rudder is located away from the propeller slipstream, then the rudder-propeller interaction coefficient will approach zero.

9.6 Azimuthing Propellers

ShipMo3D can model azimuthing propellers, which were introduced in Version 2. The treatment of azimuthing propellers is described in Reference 23. It should be noted ShipMo3D motion predictions for ships with azimuthing propellers haven't been validated yet with experimental ship motion data.

ShipMo3D uses the approach of Stettler, Hover, and Triantafyllou [24] for modelling the forces on an azimuthing propeller. Figure 18 shows the forces acting on a representative azimuthing propeller. The propeller has an azimuthal deflection of δ . The effective incident flow velocity relative to the propeller is $V_{aziprop}$, which includes contributions from the ship speed, the wave-induced ship motions, and incident waves. The total flow attack angle is $\alpha_{aziprop}$, which includes the effect of both the incident flow direction and the azimuthal deflection of the propeller. The azimuthing propeller produces a thrust force F^T along the axial direction of the propeller, and a normal force F^N . Experimental data published by Brandner and Renilson [25], Stettler et al. [24], and Islam et al. [26] indicate that the normal force component can be surprisingly large.

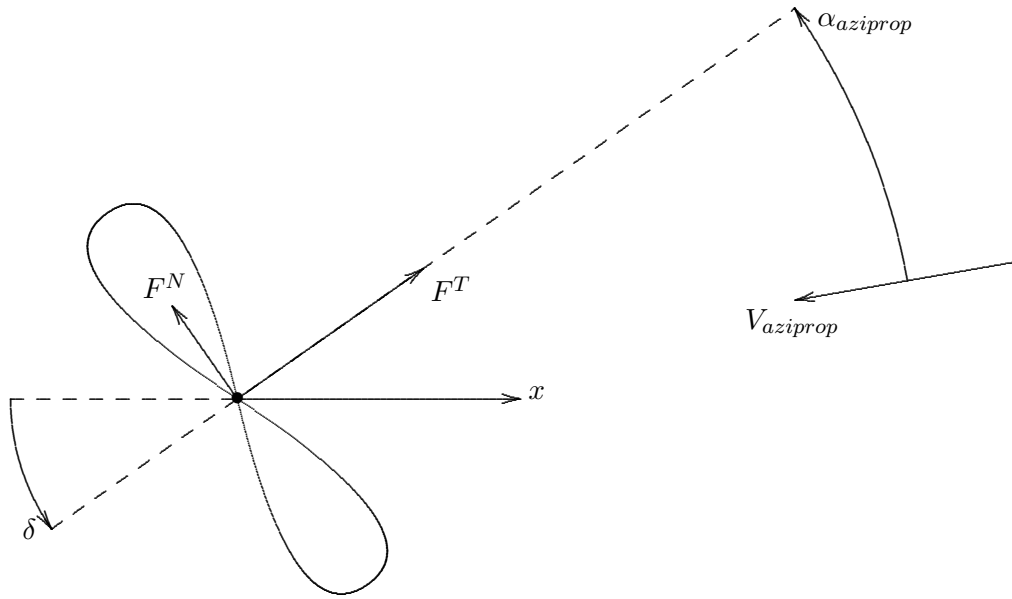

Figure 18: Thrust and Normal Forces Acting on an Azimuthing Propeller in Incident Flow

The forces acting on the propeller are represented as follows:

$$F^T = \rho n_{aziprop}^2 D_{aziprop}^4 K_T(\alpha_{aziprop}, J_{aziprop}) \quad (25)$$

$$F^N = \rho n_{aziprop}^2 D_{aziprop}^4 K_N(\alpha_{aziprop}, J_{aziprop}) \quad (26)$$

where F^T is the thrust force, $n_{aziprop}$ is the rotations per second, $D_{aziprop}$ is the diameter, K_T is thrust force coefficient, and K_N is normal force coefficient. The advance coefficient is given by:

$$J_{aziprop} = \frac{V_{aziprop}}{n_{aziprop} D_{aziprop}} \quad (27)$$

Once the thrust and normal forces have been evaluated, the forces in ship-based axes are evaluated. For example, the ship-based forces from a standard azimuthing propeller with vertical orientation Γ of -90° are:

$$F_1^{aziprop} = (1 - t_{aziprop}) (F^T \cos \delta - F^N \sin \delta) \quad (28)$$

$$F_2^{aziprop} = F^T \sin \delta + F^N \cos \delta \quad (29)$$

where $F_1^{aziprop}$ is the surge force and $F_2^{aziprop}$ is the sway force acting on the ship.

The influence of the hull on the incident flow velocity $V_{aziprop}$ is modelled using a wake fraction $w_{aziprop}$ which is applied to flow along the ship longitudinal axis and a flow straightening coefficient $\gamma_{aziprop}$ which is applied to flow along the ship transverse axis.

Figures 19 and 20 show representative thrust and normal force coefficients for an azimuthing propeller. The data in these figures are based primarily on experimental data presented by Islam et al. [26].

9.7 U-tube Tanks and Sloshing Tanks

ShipMo3D Version 3 introduces capabilities for modelling U-tube tanks and sloshing tanks. The treatment of sloshing tanks is described in Sections 7 and 8. The modelling of U-tube tanks within ShipMo3D is described in detail in Reference 8. Figure 21 shows an aft view of a U-tube tank, including the fluid displacement angle τ , which is introduced as an additional degree of freedom when solving ship motions. Figure 22 shows ShipMo3D input dimensions for a U-tube tank.

If a ship includes a U-tube tank or sloshing tank, then the tank fluid mass should be included when specifying location of the ship centre of gravity. The influence of a tank on effective metacentric height does not need to be considered when specifying the metacentric height correction for a ship if the tank is explicitly described using input for a U-tube tank or sloshing tank.

9.8 Computation of Ship Propeller RPM for Specified Ship Speeds

SM3DBuildShip includes a capability for determining ship propeller RPM for specified ship speeds. This capability is available for both azimuthing and non-azimuthing propellers. An iterative process is used to determine the actual RPM (within a specified tolerance) for ship speeds. This feature is very useful for determining what RPM should be used for subsequent simulations with SM3DFreeMo.

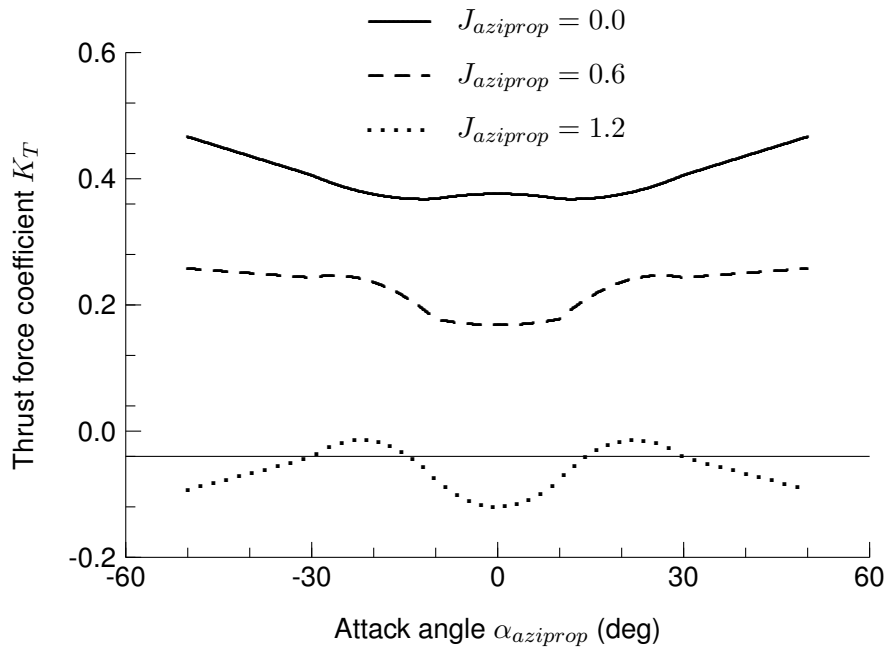

Figure 19: Thrust Force Coefficient for Example Azimuthing Propeller

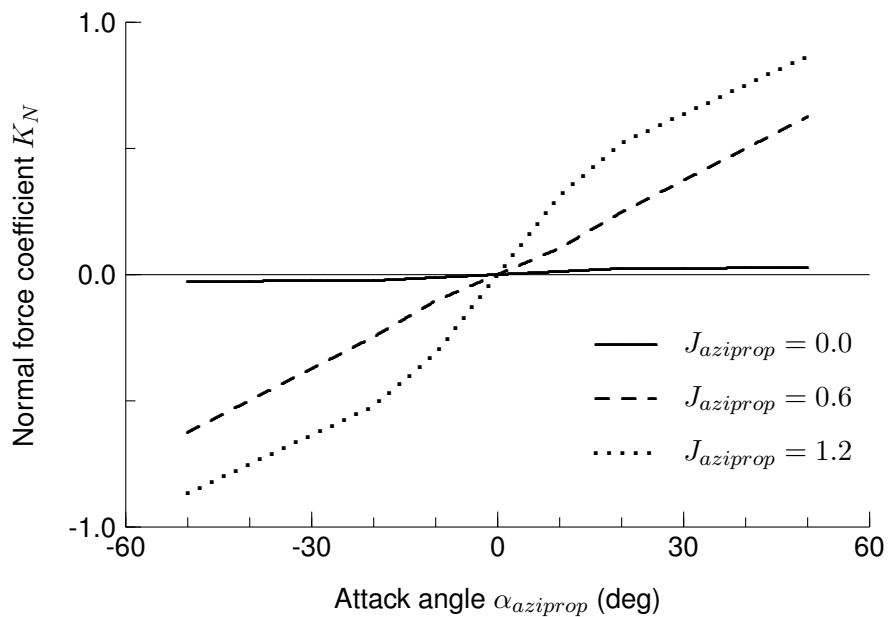

Figure 20: Normal Force Coefficient for Example Azimuthing Propeller

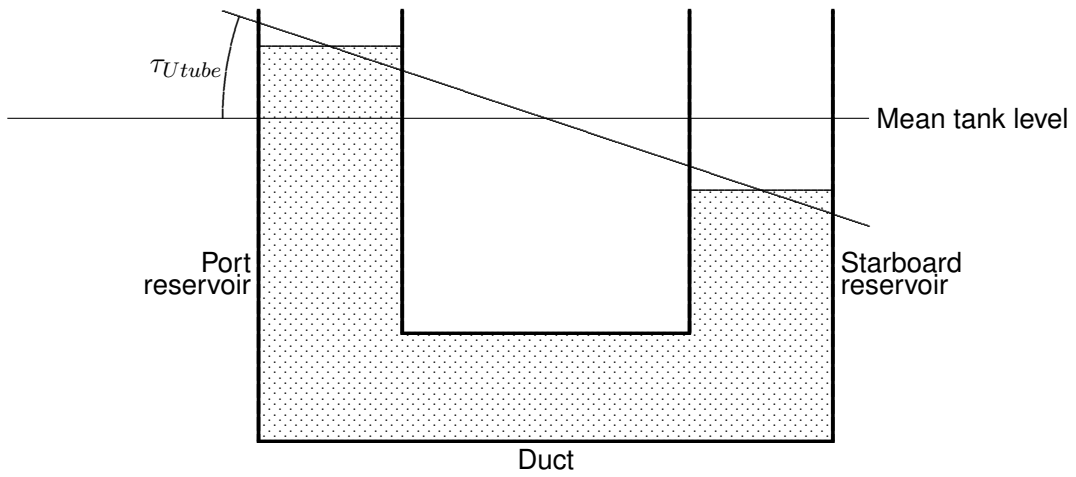

Figure 21: Aft View of U-tube Tank with Fluid Displacement Angle

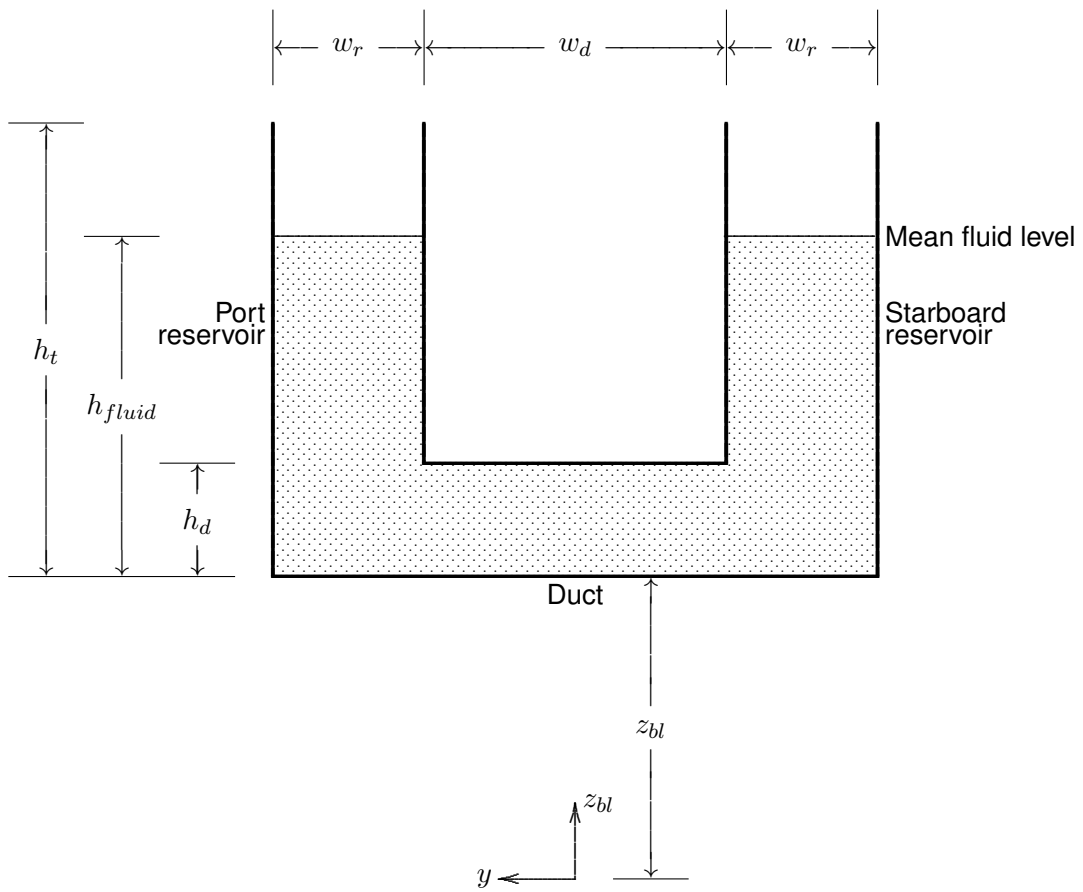

Figure 22: Aft View with ShipMo3D Input Dimensions for U-tube Tank

10 Conclusions

ShipMo3D applications can be used to build a ship model that can be used for predicting ship motions in waves. A separate user manual [1] describes applications for predicting ship motions in the time and frequency domains.

References

- [1] McTaggart, K.A. (2011). ShipMo3D Version 3.0 User Manual for Computing Ship Motions in the Time and Frequency Domains. (DRDC Atlantic TM 2011-308). Defence Research and Development Canada - Atlantic.
- [2] McTaggart, K.A. (2002). Three Dimensional Ship Hydrodynamic Coefficients Using the Zero Forward Speed Green Function. (DRDC Atlantic TM 2002-059). Defence Research and Development Canada - Atlantic.
- [3] McTaggart, K.A. (2003). Hydrodynamic Forces and Motions in the Time Domain for an Unappended Ship Hull. (DRDC Atlantic TM 2003-104). Defence Research and Development Canada - Atlantic.
- [4] McTaggart, K.A. (2003). Modelling and Simulation of Seaways in Deep Water for Simulation of Ship Motions. (DRDC Atlantic TM 2003-190). Defence Research and Development Canada - Atlantic.
- [5] McTaggart, K.A. (2004). Appendage and Viscous Forces for Ship Motions in Waves. (DRDC Atlantic TM 2004-227). Defence Research and Development Canada - Atlantic.
- [6] McTaggart, K.A. (2005). Simulation of Hydrodynamic Forces and Motions for a Freely Maneuvering Ship in a Seaway. (DRDC Atlantic TM 2005-071). Defence Research and Development Canada - Atlantic.
- [7] McTaggart, K.A. (2008). Improved Maneuvering Forces and Autopilot Modelling for the ShipMo3D Ship Motion Library. (DRDC Atlantic TM 2008-162). Defence Research and Development Canada - Atlantic.
- [8] McTaggart, K.A. (2011). Modelling of U-tube Tanks for ShipMo3D Ship Motion Predictions. (DRDC Atlantic ECR 2011-300). Defence Research and Development Canada - Atlantic.
- [9] McTaggart, K.A. (2011). Modelling of Sloshing in Free Surface Tanks for ShipMo3D Ship Motion Predictions. (DRDC Atlantic ECR 2011-084). Defence Research and Development Canada - Atlantic.
- [10] McTaggart, K.A. (2011). Validation of ShipMo3D Version 3.0 User Applications for Simulation of Ship Motions. (DRDC Atlantic TM 2011-306). Defence Research and Development Canada - Atlantic.
- [11] McTaggart, K.A. (2010). ShipMo3D Version 2.0 User Manual for Simulating Motions of a Freely Maneuvering Ship in a Seaway. (DRDC Atlantic TM 2010-131). Defence Research and Development Canada - Atlantic.

- [12] McTaggart, K.A. (2010). ShipMo3D Version 2.0 User Manual for Frequency Domain Analysis of Ship Seakeeping in a Seaway. (DRDC Atlantic TM 2010-132). Defence Research and Development Canada - Atlantic.
- [13] Nam, Bo-Woo, Kim, Yonghwan, Kim, Dae-Woong, and Kim, Yong-Soo (2009). Experimental and Numerical Studies on Ship Motion Responses Coupled with Sloshing in Waves. *Journal of Ship Research*, **53**(2), 68–82.
- [14] Lloyd, A.R.J.M. (1998). Seakeeping: Ship Behaviour in Rough Weather, Revised ed. Gosport, England: A.R.J.M. Lloyd publisher.
- [15] Malenica, S., Zalar, M., and Chen, X.B. (2003). Dynamic Coupling of Seakeeping and Sloshing. In *Thirteenth International Offshore and Polar Engineering Conference*, Honolulu, Hawaii.
- [16] Newman, J.N. (1989). Wave Effects on Vessels with Internal Tanks. In *Twentieth International Workshop on Water Waves and Floating Bodies*, pp. 201–204. Oystese, Norway.
- [17] Colwell, J.L. (1994). Motion Sickness Habituation in the Naval Environment. (DREA TM 94/211). Defence Research Establishment Atlantic.
- [18] McTaggart, K.A. (2000). SHIPOP2: An Updated Program for Computing Ship Operability in Waves and Wind. (DREA TM 2000-138). Defence Research Establishment Atlantic.
- [19] Piegl, L. and Tiller, W. (1997). The NURBS Book, 2nd ed. Berlin: Springer.
- [20] Molin, B., Remy, F., Rigaud, S., and de Jouette, C. (2002). LNG-FPSO's: Frequency Domain, Coupled Analysis of Support and Liquid Cargo Motions. In *International Maritime Association of the Mediterranean Conference*, Rethymnon, Greece.
- [21] Inoue, S., Hirano, M., and Kijima, K. (1981). Hydrodynamic Derivatives on Ship Manoeuvring. *International Shipbuilding Progress*, **28**(321), 112–125.
- [22] Smith, T.C. (1999). T-ADC(X) Maneuvering in Waves Study Using FREDYN. (Report NSWCCD-50-TR-1999\038). NSWCCD.
- [23] McTaggart, K. (2008). Active Roll Stabilization of a Coastal Naval Vessel Using Azimuthing Propellers. In *Eighteenth International Offshore and Polar Engineering Conference (ISOPE 2008)*, Vancouver.
- [24] Stettler, J.W., Hover, F.S., and Triantafyllou, M.S. (2004). Preliminary Results of Testing of the Dynamics of an Azimuthing Podded Propulsor Relating to Vehicle Manoeuvring. In *First International Conference on Technological Advances in Podded Propulsion (T-POD)*, Newcastle, UK.

- [25] Brandner, P. and Renilson, M. (1998). Interaction Between Two Closely Spaced Azimuthing Thrusters. *Journal of Ship Research*, **42**(1), 15–32.
- [26] Islam, M.F., Veitch, B., Akinturk, A., Bose, N., and Liu, P. (2007). Experiments with Podded Propulsors in Static Azimuthing Conditions. In *Proceedings of the Eighth Canadian Marine Hydromechanics and Structures Conference*, St. John's, Newfoundland.
- [27] Holtrop, J. (1984). A Statistical Re-analysis of Resistance and Propulsion Data. *International Shipbuilding Progress*, **31**(363), 272–276.

Symbols and Abbreviations

$[A]$	ship added mass matrix
A_{y-i}	lateral profile area of hull section i
A_w	hull wetted surface area
$[B]$	ship damping matrix
B_{max}	ship maximum beam
C_B	hull block coefficient
C_{Dx}	hull resistance coefficient
C_{Dy}	hull cross-flow drag coefficient
C_{eddy}^{hull}	hull eddy coefficient
C_W	hull waterplane coefficient
c_{root}	root chord length
c_{tip}	tip chord length
$[D]$	influence matrix for flow normal velocities from source strengths
$D_{aziprop}$	azimuthing propeller diameter
D_{prop}	propeller diameter
$[E]$	influence matrix for hull flow potentials from source strengths
F^N	azimuthing propeller force normal to propeller axis
F^T	azimuthing propeller thrust force along propeller axis
$F_1^{aziprop}$	azimuthing propeller force in surge direction
$F_2^{aziprop}$	azimuthing propeller force in sway direction
$\{F^{cross}\}$	cross-flow drag vector
$F_4^{hull-eddy}$	hull eddy roll damping force
$\{F^{prop}\}$	propulsion force vector
$\{F^{resist}\}$	resistance force vector
g	gravitational acceleration
h_d	height of U-tube tank central duct
h_{fluid}	height of fluid in sloshing tank or U-tube tank

h_t	height of U-tube tank
h_{tank}	height of sloshing tank
$J_{aziprop}$	azimuthing propeller advance coefficient (based on total velocity)
J_{prop}	propeller advance coefficient (based on forward velocity)
K_N	azimuthing propeller normal force coefficient
K_T	propeller thrust coefficient
K_T^0, K_T^J, K_T^{JJ}	propeller thrust quadratic coefficients
\overline{KG}	vertical centre of gravity relative to baseline
$k_{\delta j}^D$	rudder autopilot derivative gain for motion mode j
$k_{\delta j}^I$	rudder autopilot integral gain for motion mode j
$k_{\delta j}^P$	rudder autopilot proportional gain for motion mode j
L	ship length between perpendiculars
L_{middle}	length of narrow middle of sloshing tank
L_{tank}	length of sloshing tank
N'_r	linear yaw-yaw maneuvering force coefficient
$N'_{r r }$	yaw velocity dependent nonlinear yaw-yaw hull force coefficient
N'_{rv^2}	sway velocity dependent nonlinear yaw-yaw hull force coefficient
N_{seg}	number of hull longitudinal sections
N'_v	linear yaw-sway maneuvering force coefficient
N'_{vr^2}	yaw velocity dependent nonlinear yaw-sway hull force coefficient
n_j	normal component j for vector pointing outward from ship
n_j^{fl}	normal vector pointing into sloshing tank fluid
$n_{aziprop}$	azimuthing propeller speed in revolutions per second
n_{prop}	propeller speed in revolutions per second
RPM^{prop}	propeller RPM
\dot{RPM}^{prop}	time derivative of propeller RPM
\ddot{RPM}^{prop}	second derivative with respect to time of propeller RPM
RPM_C^{prop}	command propeller RPM

r_{44}	roll radius of gyration
r_{55}	pitch radius of gyration
r_{66}	yaw radius of gyration
S_{hull}	hull wetted surface
s	foil span
T_p	peak wave period
T_z	zero-crossing period
T_1	average wave period
$t_{aziprop}$	azimuthing propeller thrust deduction coefficient
t_{prop}	propeller thrust deduction coefficient
U	ship forward speed
$V_{aziprop}$	azimuthing propeller total incident flow velocity
V_{fluid}	volume of fluid in sloshing tank
v^{cross}	cross-flow velocity
$w_{aziprop}$	azimuthing propeller wake fraction
w_d	width of U-tube tank central duct
w_{middle}	width of narrow middle of sloshing tank
w_{prop}	propeller wake fraction
w_r	width of U-tube tank side reservoir
w_{tank}	width of sloshing tank
x, y, z	coordinates in translating earth axes
x_f, y_f	horizontal plane coordinates in earth-fixed axes
Y'_r	linear sway-yaw maneuvering force coefficient
$Y'_{v r }$	yaw velocity dependent nonlinear sway-yaw hull force coefficient
Y'_v	linear sway-sway maneuvering force coefficient
$Y'_{v r }$	yaw velocity dependent nonlinear sway-sway hull force coefficient
$Y'_{v v }$	sway velocity dependent nonlinear sway-sway hull force coefficient
z_{bl}	vertical coordinate relative to ship baseline

z_{bl}^{tank}	height of sloshing tank bottom above ship baseline
$\alpha_{aziprop}$	flow angle of attack for azimuthing propeller
β_s	sea direction relative to ship
Γ	appendage dihedral angle
$\gamma_{aziprop}$	azimuthing propeller flow straightening coefficient
$\Delta\tau$	retardation function time interval
δ_{rudder}	rudder deflection angle
$\dot{\delta}_{rudder}$	rudder velocity
$\ddot{\delta}_{rudder}$	rudder acceleration
δ_C^{rudder}	command rudder angle
ϵ_{tank}	fluid damping for sloshing tank
$\hat{\epsilon}_{tank}$	peak fluid damping for sloshing tank
ζ_{RPM}	propeller RPM response damping
ζ_δ	rudder nondimensional damping response constant
η_j	motion displacement for mode j in translating-earth coordinates
η_j^f	ship motion displacement for mode j in fixed-earth coordinates
$\dot{\eta}_j$	ship motion velocity for mode j in translating-earth coordinates
λ_n^{slosh}	dimensional term for sloshing mode n
ν	wave direction (from) in earth-fixed axes
$\bar{\nu}$	mean wave direction (from) in earth-fixed axes
ρ	water density
$\{\sigma\}$	vector of hull source strengths
τ	delay time for retardation function
τ_{max}	maximum time for retardation function
τ_{Utube}	fluid displacement angle for U-tube tank
$\{\phi\}$	vector of hull flow potentials
$\{\partial\phi/\partial n\}$	vector of flow normal velocities
ϕ_j^{slosh}	frequency domain sloshing potential for ship motion mode j

χ	ship heading (to) in earth-fixed axes
ω_e	encounter frequency
ω_I	incident wave frequency
$\omega_{lower}^{\hat{e}}$	lower frequency for peak sloshing flow damping
ω_n^{slosh}	frequency of sloshing mode n
ω_{RPM}	propeller RPM response natural frequency
$\omega_{upper}^{\hat{e}}$	upper frequency for peak sloshing flow damping
ω_δ	rudder response natural frequency
Δ	displacement

Annex A: Files for Panelling the Hull with SM3DPanelHull3

A.1 Format of Input File for SM3DPanelHull3

Record (1), Beginning Record

“begin SM3DPanelHull3” (1 character string with 2 words)

Record (2), Run Title

“label”, label (2 character strings)

“label” Record tag.

label Title for run. This can include spaces.

Record (3), Beginning of Note

Input Records (3) to (3b) can optionally be used together to give a descriptive note regarding input.

“begin note” (1 character string with 2 words)

Record (3a), Note

Input Records (3) to (3b) can optionally be used together to give a descriptive note regarding input.

noteText (character string)

noteText Text of note. Multiple lines can be entered.

Record (3b), End of Note

Input Records (3) to (3b) can optionally be used together to give a descriptive note regarding input.

“end note” (1 character string with 2 words)

Record (4), Run Type

“runOption”, runOption (2 character strings)

“runOption” Record tag.

runOption Option for run.

Full - Full run including panelling of hull.

NoPanel - No panelling of the hull. This run type can be used for checking of the patch hull.

Record (5), Patch Hull Input File Name

“patchHullInputFileName”, patchHullInputFileName (2 character strings)

“patchHullInputFileName” Record tag.

patchHullInputFileName Name of input file with description of patch hull.

Record (6), Patch Hull Data File Name

“patchHullDataFileName”, patchHullDataFileName (2 character strings)

“patchHullDataFileName” Record tag.

patchHullDataFileName Name of file to be written with binary representation of patch hull.

Record (7), Wet Patch Hull Data File Name

“wetPatchHullDataFileName”, wetPatchHullDataFileName (2 character strings)

“wetPatchHullDataFileName” Record tag.

wetPatchHullDataFileName Name of file to be written with binary representation of wet patch hull.

Record (8), Dry Patch Hull Data File Name

“dryPatchHullDataFileName”, dryPatchHullDataFileName (2 character strings)

“dryPatchHullDataFileName” Record tag.

dryPatchHullDataFileName Name of file to be written with binary representation of dry patch hull.

Record (9), Length Data

“lengthData”, lpp, stationAP (1 character string, 2 floats)

“lengthData” Record tag.

lpp Ship length between perpendiculars (m)

stationAP Station number of the aft perpendicular. This value is typically 20.0

Note: The values in this record must agree with the values used for the patch hull input file patchHullInputFileName from Record (5). Values are considered to be in agreement when they are within a tolerance of 0.001 m for length, and 0.001 for the station of the aft perpendicular.

Record (10), Patch Parameters for Fitting B-splines to Surfaces

This record is optional.

“patchFitParam”, nuMax, nvMax, spacingMin, puMax, pvMax (1 character string, 2 integers, 1 float, 2 integers)

“patchFitParam” Record tag.

nuMax Maximum number of control segments in u direction for fitted patch (default 40). Must be in the range $5 \leq \text{nuMax} \leq 40$.

nvMax Maximum number of control segments in v direction for fitted patch (default 40). Must be in the range $5 \leq \text{nvMax} \leq 40$.

spacingMin Minimum nominal spacing between control points on a fitted surface (default $\approx 0.001L_{pp}$). This value must be $\leq 0.01L_{pp}$.

puMax Maximum degree of fitted B-splines in u direction (default 3).

pvMax Maximum degree of fitted B-splines in v direction (default 3).

Record (11), Plot Output Option

This record is optional.

“plotOutOption”, plotOutOption (2 character strings)

“plotOutOption” Record tag.

plotOutOption Option for making plots.

NoPlots - No plots are produced.

ScreenFile - Plots are both plotted on the screen and to a file.

Screen - Plots are only plotted on the screen.

File - Plots are only written to a file (default).

Record (12), Beginning of Patch Hull Line Plot Data

This record is optional.

“begin patchLinePlots” (1 character string with 2 words)

Note: If this record is entered, then it can be followed by an arbitrary number of repetitions of Records (12a) to (12g) giving plot parameters. Record (12h) must follow at the end of plot parameter data.

Record (12a), Patch Hull Image File Name

This record is required if a plot is being specified.

“imageFileName”, imageFileName (2 character strings)

“imageFileName” Record tag.

imageFileName Name of output plot file.

Record (12b), Patch Hull Line Image Format

This record is optional if a plot is being specified.

“imageFormat”, imageFormat (2 character strings)

“imageFormat” Record tag.

imageFormat Plot image format. Available formats are png (default) and jpg.

Record (12c), Patch Hull Line Image Size

This record is optional if a plot is being specified.

“imageSize”, widthmm, heightmm (1 character string, 2 floats)

“imageSize” Record tag.

widthmm Plot width (mm). (Default 150 mm)

heightmm Plot height (mm). (Default 100 mm)

Record (12d), Patch Hull Line Camera Settings

This record is required if a plot is being specified.

“camera”, camPosHorAngleDeg, camPosVertAngleDeg, camViewAngleDeg (1 character string, 3 floats)

“camera” Record tag.

camPosHorAngleDeg Horizontal position (deg) of camera relative to ship (0 deg for front, 90 deg for left).

camPosVertAngleDeg Vertical position (deg) of camera relative to ship (0 deg for horizontal, 90 deg for above).

camViewAngleDeg Camera view angle (deg).

Record (12e), Patch Hull Line Lighting Settings

This record is optional if a plot is being specified.

“lighting”, ambientLightIntensity, directLightIntensity, directLightHorAngleDeg, directLightVertAngleDeg (1 character string, 3 floats)

“lighting” Record tag.

ambientLightIntensity Ambient light intensity (default 0.5).

directLightIntensity Direct light intensity (default 1.0).

directLightHorAngleDeg Horizontal position (deg) of direct light source relative to ship (0 deg for front, 90 deg for left, default 0 deg).

directLightVertAngleDeg Vertical position (deg) of direct light source relative to ship (0 deg for horizontal, 90 deg for above, default 45 deg).

Record (12f), Patch Hull Line Plot Show Starboard Option

This record is optional if a plot is being specified.

“showStarboardOption”, showStarboardOption (2 character strings)

“showStarboardOption” Record tag.

showStarboardOption Option for showing starboard portion of hull.

ShowStarboard - Both sides of hull are shown (default).

HideStarboard - Only port side of hull is shown.

Record (12g), Patch Hull Line Thicknesses

This record is optional if a plot is being specified.

“lineThicknesses”, lineThickness, edgeLineThickness (1 character string, 2 integers)

“lineThicknesses” Record tag.

lineThickness Line thickness of patch hull lines (default 3.0).

edgeLineThickness Line thickness of lines along patch edges (default 1.0).

Record (12h), End of Plot Data

This record is required if Record (12) has been entered.

“end patchLinePlots” (1 character string with 2 words)

Record (13), Beginning of Patch Hull Surface Plot Data

This record is optional.

“begin patchSurfacePlots” (1 character string with 2 words)

Note: If this record is entered, then it can be followed by an arbitrary number of repetitions of Records (13a) to (13h) giving plot parameters. Record (13i) must follow at the end of plot parameter data.

Record (13a), Patch Hull Surface Image File Name

This record is required if a plot is being specified.

“imageFileName”, imageFileName (2 character strings)

“imageFileName” Record tag.

imageFileName Name of output plot file.

Record (13b), Patch Hull Surface Image Format

This record is optional if a plot is being specified.

“imageFormat”, imageFormat (2 character strings)

“imageFormat” Record tag.

imageFormat Plot image format. Available formats are png (default) and jpg.

Record (13c), Patch Hull Surface Image Size

This record is optional if a plot is being specified.

“imageSize”, widthmm, heightmm (1 character string, 2 floats)

“imageSize” Record tag.

widthmm Plot width (mm). (Default 150 mm)

heightmm Plot height (mm). (Default 100 mm)

Record (13d), Patch Hull Surface Camera Settings

This record is required if a plot is being specified.

“camera”, camPosHorAngleDeg, camPosVertAngleDeg, camViewAngleDeg (1 character string, 3 floats)

“camera” Record tag.

camPosHorAngleDeg Horizontal position (deg) of camera relative to ship (0 deg for front, 90 deg for left).

camPosVertAngleDeg Vertical position (deg) of camera relative to ship (0 deg for horizontal, 90 deg for above).

camViewAngleDeg Camera view angle (deg).

Record (13e), Patch Hull Surface Lighting Settings

This record is optional if a plot is being specified.

“lighting”, ambientLightIntensity, directLightIntensity, directLightHorAngleDeg, directLightVertAngleDeg (1 character string, 3 floats)

“lighting”	Record tag.
ambientLightIntensity	Ambient light intensity (default 0.5).
directLightIntensity	Direct light intensity (default 1.0).
directLightHorAngleDeg	Horizontal position (deg) of direct light source relative to ship (0 deg for front, 90 deg for left, default 0 deg).
directLightVertAngleDeg	Vertical position (deg) of direct light source relative to ship (0 deg for horizontal, 90 deg for above, default 45 deg).

Record (13f), Patch Hull Surface Plot Wet/Dry Option

This record is optional if a plot is being specified.

“wetDryOption”, wetDry (2 character strings)

“wetDryOption”	Record tag.
wetDryOption	Option for hull to be displayed. Full - The full patch hull is shown (default). Wet - The trimmed wet patch hull is shown. Dry - The trimmed dry patch hull is shown.

Record (13g), Patch Hull Surface Plot Colour

This record is optional if a plot is being specified.

“patchHullColour”, patchHullColour (2 character strings)

“patchHullColour” Record tag.

patchHullColour Hull colour, which can be one of:

Multi - Each hull patch is assigned a colour (default).

Red.

Green.

Yellow.

Grey.

Record (13h), Patch Hull Surface Plot Show Starboard Option

This record is optional if a plot is being specified.

“showStarboardOption”, showStarboardOption (2 character strings)

“showStarboardOption” Record tag.

showStarboardOption Option for showing starboard portion of hull:

ShowStarboard - Both sides of hull are shown (default).

HideStarboard - Only port side of hull is shown.

Record (13i), End of Patch Hull Surface Plot Data

This record is required if Record (13) has been entered.

“end patchSurfacePlots” (1 character string with 2 words)

Record (14), Wet Panel Hull File Name

“wetPanelFileName”, wetPanelFileName (2 character strings)

“wetPanelFileName” Record tag.

wetPanelFileName Name of output file describing hull in .NET binary serialization format.

Record (15), Dry Panel Hull Option

“dryPanelOption”, dryPanelOption (2 character strings)

“dryPanelOption” Record tag.

dryPanelOption Option for panelling dry portion of hull.

DryPanel - Dry portion of hull is panelled.

NoDryPanel - Dry portion of hull is not panelled.

Note: If the option DryPanel is selected, then the input patch hull should describe a fully enclosed volume.

Record (15a), Dry Panel Hull File Name

This record is only required if dryPanelOption is set to dryPanel in Record (15).

“dryPanelFileName”, dryPanelFileName (2 character strings)

“dryPanelFileName” Record tag.

dryPanelFileName Name of output file describing hull in .NET binary serialization format.

Record (16), Water Density

“waterDensity”, waterDensity (1 character string, 1 float)

“waterDensity” Record tag.

waterDensity Water density (kg/m^3). For salt water, a value of $1025 \text{ kg}/\text{m}^3$ is recommended. For fresh water, a value of $1000 \text{ kg}/\text{m}^3$ is recommended.

Record (17), Draft and Trim

One of this record or Record (18) is required.

“draftTrim”, draftBlMid, trimBlStern (1 character string, 2 floats)

“draftTrim” Record tag.

draftBlMid Draft of baseline at midships (m).

trimBlStern Trim by stern (m).

Record (18), Displacement and LCG Location

One of this record or Record (17) is required.

“dispLCG”, dispTonnesInput, distanceFPCGInput, draftBIMidGuess, trimBlSternGuess, tolDisp, tolLcg (1 character string, 6 floats)

“dispLCG”	Record tag.
dispTonnesInput	Displacement (tonnes). This value should include the influence of fluid mass present in tanks
distanceFPCGInput	Distance from fore perpendicular to LCG (m). This value should include the influence of fluid mass present in tanks.
draftBIMidGuess	Guess for draft of baseline at midships (m).
trimBlSternGuess	Guess for trim of baseline by stern (m).
tolDisp	Non-dimensional tolerance on displacement. A value of 10^{-6} is recommended.
tolLcg	Non-dimensional tolerance on distance of LCG aft of fore perpendicular. A value of 10^{-6} is recommended.

Record (19), Height of Centre of Gravity Above Baseline

“shipKG”, shipKG (1 character string, 1 float)

“shipKG” Record tag.

shipKG Height of centre of gravity above baseline (m). This value should include the influence of fluid mass present in tanks.

Record (20), Hull Panel Parameters

“panelParameters”, areaPanelLimit, aspectPanelLimit, deltaNormalPanelLimitDeg (1 character string, 3 floats)

“panelParameters”	Record tag.
areaPanelLimit	Limit on area for hull panels (m ²).
aspectPanelLimit	Limiting hull panel aspect ratio. A value of 3.0 is recommended.
deltaNormalPanelLimitDeg	Limit on normal angle between adjacent panels. A value of 15° is recommended.

Record (21), Beginning of Panelled Hull Plot Data

This record is optional.

“begin panelPlots” (1 character string with 2 words)

Note: If this record is entered, then it can be followed by an arbitrary number of repetitions of Records (21a) to (21h) giving plot parameters. Record (21i) must follow at the end of plot parameter data.

Record (21a), Panelled Hull Image File Name

This record is required if a plot is being specified.

“imageFileName”, imageFileName (2 character strings)

“imageFileName” Record tag.

imageFileName Name of output plot file.

Record (21b), Panelled Hull Image Format

This record is optional if a plot is being specified.

“imageFormat”, imageFormat (2 character strings)

“imageFormat” Record tag.

imageFormat Plot image format. Available formats are png (default) and jpg.

Record (21c), Panelled Hull Image Size

This record is optional if a plot is being specified.

“imageSize”, widthmm, heightmm (1 character string, 2 floats)

“imageSize” Record tag.

widthmm Plot width (mm). (Default 150 mm)

heightmm Plot height (mm). (Default 100 mm)

Record (21d), Panelled Hull Camera Settings

This record is required if a plot is being specified.

“camera”, camPosHorAngleDeg, camPosVertAngleDeg, camViewAngleDeg (1 character string, 3 floats)

“camera”	Record tag.
camPosHorAngleDeg	Horizontal position (deg) of camera relative to ship (0 deg for front, 90 deg for left).
camPosVertAngleDeg	Vertical position (deg) of camera relative to ship (0 deg for horizontal, 90 deg for above).
camViewAngleDeg	Camera view angle (deg).

Record (21e), Panelled Hull Lighting Settings

This record is optional if a plot is being specified.

“lighting”, ambientLightIntensity, directLightIntensity, directLightHorAngleDeg, directLightVertAngleDeg (1 character string, 3 floats)

“lighting”	Record tag.
ambientLightIntensity	Ambient light intensity (default 0.5).
directLightIntensity	Direct light intensity (default 1.0).
directLightHorAngleDeg	Horizontal position (deg) of direct light source relative to ship (0 deg for front, 90 deg for left, default 0 deg).
directLightVertAngleDeg	Vertical position (deg) of direct light source relative to ship (0 deg for horizontal, 90 deg for above, default 45 deg).

Record (21f), Panel Hull Plot Options

This record is required if a plot is being specified.

“panelPlotOptions”, showWetDry, colourTable, showStarboardOption, smoothShadeOption (5 character strings)

“panelPlotOptions”	Record tag.
wetDryOption	Option for displacing wet and/or dry hull. Wet - Wet hull only is plotted. Dry - Dry hull only is plotted. dryPanelOption must be “DryPanel” in Record (15). WetDry - Wet and dry hulls are plotted together. dryPanelOption must be “DryPanel” in Record (15).
colourTable	Colour table. Available tables are BlueGreenRedScale, RedHullYellowApp, HullLiftSurfaceProp, WetWhiteDryGrey, GreyScale, PartialGreyScale, and White.
showStarboardOption	Option for showing starboard portion of hull. ShowStarboard - Both sides of hull are shown. HideStarboard - Only port side of hull is shown.
smoothShadeOption	Option for shading of hull panels. Solid - Each panel has a constant colour based on the centroid location. Smooth - Each panel can have colour variation within the panel.

Record (21g), Stations for Cropping Plot

This record is optional if a plot is being specified.

“cropStations”, stationMinCrop, stationMaxCrop (1 character string, 2 floats)

“cropStations”	Record tag.
stationMinCrop	Minimum station for cropping plot.
stationMaxCrop	Maximum station for cropping plot.

Note: If this record is omitted for a plot, then there is no cropping of the plot.

Record (21h), Panel Line Thickness

This record is optional if a plot is being specified.

“lineThickness”, lineThickness (1 character string, 1 float)

“lineThickness” Record tag.

lineThickness Line thickness of panels (default 1.0).

Record (21i), End of Panelled Hull Plot Data

“end panelPlots” (1 character string with 2 words)

Record (22), End of Input File for SM3DPanelHull

“end SM3DPanelHull3” (1 character string with 2 words)

A.2 Format of Input PatchHull File

Record (1), Beginning Record

“begin patchHull3” (1 character string with 2 words)

Record (2), Patch Hull Label

“label”, label (2 character strings)

“label” Record tag.

label Label for patch hull. This can include spaces.

Record (3), Length Data

“lengthData”, lpp, stationAP (1 character string, 2 floats)

“lengthData” Record tag.

lpp Ship length between perpendiculars (m)

stationAP Station number of the aft perpendicular. This value is typically 20.0

Record (4), Scaling Parameters for Offsets

This record is optional.

“scaleYZ”, yScale, zScale (1 character string, 2 floats)

“scaleYZ” Record tag.

yScale Scale factor for input y offsets. A default of 1.0 is used if this record is omitted.

zScale Scale factor for input z offsets. A default of 1.0 is used if this record is omitted.

Record (5), Beginning of Data for Hull Patch

This record is followed by repeated series of Records (5a) to (5d5), finishing with Record (5e). These groups of records can be repeated to describe an arbitrary number of patches encompassing the ship hull.

“begin patch” (1 character string with 2 words)

Record (5a), Patch Label

“label”, label (2 character strings)

“label” Record tag.

label Label for patch. This can include spaces.

Record (5b), Normal Ranges for Checking of Hull Panelling

“normalRanges”, nxMinLimit, nxMaxLimit, nyMinLimit, nyMaxLimit, nzMinLimit, nzMaxLimit (1 character string, 6 floats)

“normalRanges” Record tag.

nxMinLimit Minimum x normal component for patch surface.

nxMaxLimit Maximum x normal component for patch surface.

nyMinLimit Minimum y normal component for patch surface.

nyMaxLimit Maximum y normal component for patch surface.

nzMinLimit Minimum z normal component for patch surface.

nzMaxLimit Maximum z normal component for patch surface.

Note: The input normal ranges are intended to be broad ranges used for checking that generated panels aren't pointing in the wrong direction. Hull normals point outward from the hull.

Record (5c), Limit on Maximum Area for Panels on Patch

This record is optional

“areaPanelLimit”, areaPanelLimit (1 character string, 1 float)

“areaPanelLimit” Record tag.

areaPanelLimit Limit of maximum panel area on patch. A default of 10^{99} is used if this record is omitted. This record can be used for areas requiring a finer mesh size than the remainder of the hull, such as a bulbous bow with sharp curvature.

Record (5d), Beginning of Hull Line Data

A patch is described by repeated series of Records (5d) to (5d5) representing hull lines. A patch must consist of at least 2 hull lines.

“begin hullLine” (1 character string with 2 words)

Record (5d1), Station for Hull Line Offsets

Record (5d) must be followed by either Record (5d1) or Record (5d2). If Record (5d1) is used, then all offsets on a hull line must have the same station.

“station”, station (1 character string, 1 float)

“station” Record tag.

station Station number for all offsets on hull line. Station 0 is at the fore perpendicular.

Record (5d2), Stations for Hull Line Offsets

Record (5d) must be followed by either Record (5d1) or Record (5d2).

“stations”, stations (1 character string, nOffsets floats)

“stations” Record tag.

stations Array of nOffset station numbers, where nOffset is the number of offsets on the hull line. Station 0 is at the fore perpendicular.

Record (5d3), Y Offsets for Hull Line

“yOffsets”, yOffsets (1 character string, nOffsets floats)

“yOffsets” Record tag.

yOffsets Array of nOffset *y* offsets, where nOffset is the number of offsets on the hull line.

Record (5d4), Z Offsets for Hull Line

“zOffsets”, zOffsets (1 character string, nOffsets floats)

“zOffsets” Record tag.

zOffsets Array of nOffset *z* offsets relative to the baseline, where nOffset is the number of offsets on the hull line.

Note: Records (5d3) and (5d4) (and Record (5d2) if used) must contain data for the same number of offsets.

Record (5d5), End of Data for Hull Line

“end hullLine” (1 character string with 2 words)

Record (5e), End of Data for Patch

“end patch” (1 character string with 2 words)

Record (6), End of Data for Patch Hull

“end patchHull3” (1 character string with 2 words)

A.3 Sample Input File for SM3DPanelHull3

```
begin SM3DPanelHull3
label Generic frigate
runOption Full
patchHullInputFileName genericFrigatePatchHull3.inp
patchHullDataFileName genFrigPatchHull.bin
wetPatchHullDataFileName genFrigWetPatchHull.bin
dryPatchHullDataFileName genFrigDryPatchHull.bin
lengthData 120.000 20.000
patchFitParam 40 40 0.1 3 3
wetPanelFileName genFrigWetPanelHull.bin
dryPanelOption DryPanel
dryPanelFileName genFrigDryPanelHull.bin
waterDensity 1025.000
draftTrim 4.2 0
shipKG 6.000
panelParameters 1.500000 3.000 15.000
end SM3DPanelHull3
```

A.4 Sample Patch Hull Input File for SM3DPanelHull3

```
begin patchHull3
label Generic frigate with wide station 0 to give smooth hull
lengthData 120.0 20.0
#####
begin patch
label Smooth hull from station -1.0 to 20
normalRanges -0.5 1.0 -0.05 1.0 -1.0 0.2
begin hullLine
    stations -0.5 -1.0
    yOffsets 0.0 0.0
    zOffsets 8.0 12.2
end hullLine
begin hullLine
    station 0
    yOffsets 0.000 0.059 0.069 0.091 0.121 0.164 0.218 0.282 !
            0.357 0.440 0.532 0.633 0.740 0.857 0.981 1.113 !
            1.250 1.389 1.530 1.671 1.812 1.950 2.086 2.217 !
            2.342 2.509 2.633 2.739 2.751
    zOffsets 4.427 4.700 4.977 5.253 5.530 5.806 6.083 6.359 !
            6.636 6.912 7.189 7.465 7.742 8.018 8.295 8.571 !
            8.848 9.124 9.401 9.677 9.954 10.230 10.507 10.783 !
            11.060 11.462 11.793 12.125 12.166
end hullLine
begin hullLine
    station 1
    yOffsets 0.000 0.169 0.283 0.387 0.485 0.575 0.656 0.728 !
            0.795 0.862 0.929 0.998 1.066 1.135 1.205 1.275 !
            1.346 1.417 1.491 1.565 1.641 1.719 1.799 1.884 !
            1.972 2.065 2.163 2.265 2.371 4.849
    zOffsets 0.000 0.000 0.276 0.553 0.829 1.106 1.382 1.659 !
            1.935 2.212 2.488 2.765 3.041 3.318 3.594 3.871 !
            4.147 4.424 4.700 4.977 5.253 5.530 5.806 6.083 !
            6.359 6.636 6.912 7.189 7.465 11.889
end hullLine
begin hullLine
    station 2
    yOffsets 0.000 0.169 0.449 0.693 0.902 1.085 1.250 1.404 !
            1.547 1.683 1.816 1.944 2.069 2.189 2.304 2.415 !
            2.523 2.630 2.736 2.840 2.944 3.048 3.153 3.260 !
            3.368 3.478 3.591 3.707 3.827 5.942
    zOffsets 0.000 0.000 0.276 0.553 0.829 1.106 1.382 1.659 !
            1.935 2.212 2.488 2.765 3.041 3.318 3.594 3.871 !
            4.147 4.424 4.700 4.977 5.253 5.530 5.806 6.083 !
```

```

        6.359  6.636  6.912  7.189  7.465 11.613
end hullLine
begin hullLine
  station 3
  yOffsets  0.000  0.169  0.684  1.073  1.394  1.662  1.896  2.111 !
            2.312  2.503  2.685  2.861  3.029  3.191  3.345  3.492 !
            3.632  3.767  3.895  4.019  4.139  4.254  4.367  4.477 !
            4.585  4.692  4.796  4.900  5.004  6.504
  zOffsets  0.000  0.000  0.276  0.553  0.829  1.106  1.382  1.659 !
            1.935  2.212  2.488  2.765  3.041  3.318  3.594  3.871 !
            4.147  4.424  4.700  4.977  5.253  5.530  5.806  6.083 !
            6.359  6.636  6.912  7.189  7.465 11.336
end hullLine
begin hullLine
  station 4
  yOffsets  0.000  0.169  1.095  1.637  2.035  2.367  2.653  2.908 !
            3.142  3.361  3.567  3.762  3.950  4.130  4.302  4.464 !
            4.618  4.760  4.893  5.017  5.132  5.240  5.341  5.435 !
            5.523  5.607  5.688  5.767  5.845  6.878
  zOffsets  0.000  0.000  0.276  0.553  0.829  1.106  1.382  1.659 !
            1.935  2.212  2.488  2.765  3.041  3.318  3.594  3.871 !
            4.147  4.424  4.700  4.977  5.253  5.530  5.806  6.083 !
            6.359  6.636  6.912  7.189  7.465 11.060
end hullLine
begin hullLine
  station 5
  yOffsets  0.000  0.169  1.341  2.094  2.620  3.032  3.376  3.675 !
            3.940  4.180  4.399  4.601  4.788  4.962  5.123  5.272 !
            5.410  5.537  5.653  5.759  5.857  5.945  6.027  6.101 !
            6.171  6.236  6.298  6.357  6.415  7.113
  zOffsets  0.000  0.000  0.276  0.553  0.829  1.106  1.382  1.659 !
            1.935  2.212  2.488  2.765  3.041  3.318  3.594  3.871 !
            4.147  4.424  4.700  4.977  5.253  5.530  5.806  6.083 !
            6.359  6.636  6.912  7.189  7.465 10.783
end hullLine
begin hullLine
  station 6
  yOffsets  0.000  0.169  1.428  2.435  3.134  3.655  4.061  4.393 !
            4.675  4.921  5.137  5.329  5.502  5.658  5.800  5.928 !
            6.045  6.151  6.247  6.334  6.412  6.483  6.545  6.601 !
            6.652  6.699  6.744  6.788  6.831  7.301
  zOffsets  0.000  0.000  0.276  0.553  0.829  1.106  1.382  1.659 !
            1.935  2.212  2.488  2.765  3.041  3.318  3.594  3.871 !
            4.147  4.424  4.700  4.977  5.253  5.530  5.806  6.083 !
            6.359  6.636  6.912  7.189  7.465 10.507

```



```

end hullLine
begin hullLine
station 7
  yOffsets  0.000  0.169  1.428  2.646  3.555  4.188  4.658  5.023 !
             5.320  5.565  5.772  5.948  6.098  6.228  6.339  6.436 !
             6.520  6.595  6.661  6.721  6.776  6.826  6.872  6.913 !
             6.950  6.984  7.017  7.050  7.082  7.411
  zOffsets  0.000  0.000  0.276  0.553  0.829  1.106  1.382  1.659 !
             1.935  2.212  2.488  2.765  3.041  3.318  3.594  3.871 !
             4.147  4.424  4.700  4.977  5.253  5.530  5.806  6.083 !
             6.359  6.636  6.912  7.189  7.465  10.230
end hullLine
begin hullLine
station 8
  yOffsets  0.000  0.169  1.428  2.687  3.813  4.587  5.120  5.504 !
             5.799  6.033  6.222  6.376  6.503  6.607  6.692  6.762 !
             6.820  6.870  6.913  6.951  6.987  7.020  7.052  7.083 !
             7.114  7.145  7.175  7.204  7.231  7.478
  zOffsets  0.000  0.000  0.276  0.553  0.829  1.106  1.382  1.659 !
             1.935  2.212  2.488  2.765  3.041  3.318  3.594  3.871 !
             4.147  4.424  4.700  4.977  5.253  5.530  5.806  6.083 !
             6.359  6.636  6.912  7.189  7.465  9.954
end hullLine
begin hullLine
station 9
  yOffsets  0.000  0.169  1.428  2.687  3.915  4.792  5.416  5.826 !
             6.120  6.341  6.511  6.644  6.749  6.831  6.895  6.946 !
             6.986  7.021  7.051  7.080  7.108  7.135  7.162  7.188 !
             7.214  7.239  7.265  7.291  7.316  7.521
  zOffsets  0.000  0.000  0.276  0.553  0.829  1.106  1.382  1.659 !
             1.935  2.212  2.488  2.765  3.041  3.318  3.594  3.871 !
             4.147  4.424  4.700  4.977  5.253  5.530  5.806  6.083 !
             6.359  6.636  6.912  7.189  7.465  9.677
end hullLine
begin hullLine
station 10
  yOffsets  0.000  0.169  1.428  2.687  3.947  4.963  5.568  5.972 !
             6.262  6.475  6.635  6.758  6.853  6.926  6.981  7.021 !
             7.048  7.072  7.096  7.120  7.144  7.169  7.193  7.217 !
             7.241  7.265  7.290  7.314  7.338  7.507
  zOffsets  0.000  0.000  0.276  0.553  0.829  1.106  1.382  1.659 !
             1.935  2.212  2.488  2.765  3.041  3.318  3.594  3.871 !
             4.147  4.424  4.700  4.977  5.253  5.530  5.806  6.083 !
             6.359  6.636  6.912  7.189  7.465  9.401
end hullLine

```

```

begin hullLine
station 11
  yOffsets  0.000  0.169  1.428  2.687  3.956  4.930  5.513  5.913 !
             6.207  6.429  6.598  6.729  6.829  6.905  6.960  7.001 !
             7.033  7.060  7.086  7.115  7.144  7.168  7.193  7.217 !
             7.241  7.265  7.290  7.314  7.338  7.507
  zOffsets  0.000  0.000  0.276  0.553  0.829  1.106  1.382  1.659 !
             1.935  2.212  2.488  2.765  3.041  3.318  3.594  3.871 !
             4.147  4.424  4.700  4.977  5.253  5.530  5.806  6.083 !
             6.359  6.636  6.912  7.189  7.465  9.401
end hullLine
begin hullLine
station 12
  yOffsets  0.000  0.169  1.428  2.677  3.833  4.758  5.372  5.797 !
             6.107  6.340  6.519  6.656  6.761  6.842  6.905  6.954 !
             6.994  7.028  7.058  7.087  7.116  7.143  7.170  7.198 !
             7.229  7.259  7.288  7.314  7.338  7.507
  zOffsets  0.000  0.000  0.276  0.553  0.829  1.106  1.382  1.659 !
             1.935  2.212  2.488  2.765  3.041  3.318  3.594  3.871 !
             4.147  4.424  4.700  4.977  5.253  5.530  5.806  6.083 !
             6.359  6.636  6.912  7.189  7.465  9.401
end hullLine
begin hullLine
station 13
  yOffsets  0.000  0.169  1.383  2.554  3.624  4.500  5.129  5.582 !
             5.920  6.177  6.376  6.532  6.652  6.746  6.820  6.878 !
             6.923  6.960  6.993  7.024  7.056  7.086  7.115  7.143 !
             7.169  7.193  7.218  7.242  7.266  7.437
  zOffsets  0.000  0.000  0.276  0.553  0.829  1.106  1.382  1.659 !
             1.935  2.212  2.488  2.765  3.041  3.318  3.594  3.871 !
             4.147  4.424  4.700  4.977  5.253  5.530  5.806  6.083 !
             6.359  6.636  6.912  7.189  7.465  9.401
end hullLine
begin hullLine
station 14
  yOffsets  0.000  0.169  1.314  2.364  3.311  4.126  4.745  5.228 !
             5.605  5.903  6.139  6.326  6.472  6.587  6.677  6.748 !
             6.803  6.849  6.888  6.924  6.957  6.988  7.015  7.041 !
             7.066  7.092  7.117  7.142  7.168  7.345
  zOffsets  0.000  0.000  0.276  0.553  0.829  1.106  1.382  1.659 !
             1.935  2.212  2.488  2.765  3.041  3.318  3.594  3.871 !
             4.147  4.424  4.700  4.977  5.253  5.530  5.806  6.083 !
             6.359  6.636  6.912  7.189  7.465  9.401
end hullLine
begin hullLine

```

```

station 15
  yOffsets  0.000  0.169  0.899  1.804  2.682  3.503  4.186  4.721 !
            5.147  5.494  5.776  6.005  6.189  6.337  6.456  6.551 !
            6.628  6.690  6.742  6.784  6.819  6.849  6.876  6.902 !
            6.928  6.954  6.980  7.006  7.032  7.214
  zOffsets  0.000  0.000  0.276  0.553  0.829  1.106  1.382  1.659 !
            1.935  2.212  2.488  2.765  3.041  3.318  3.594  3.871 !
            4.147  4.424  4.700  4.977  5.253  5.530  5.806  6.083 !
            6.359  6.636  6.912  7.189  7.465  9.401
end hullLine
begin hullLine
station 16
  yOffsets  0.000  0.169  0.632  1.501  2.359  3.180  3.892  4.473 !
            4.931  5.295  5.588  5.827  6.021  6.177  6.301  6.400 !
            6.478  6.540  6.591  6.631  6.663  6.690  6.718  6.745 !
            6.773  6.800  6.828  6.856  7.049
  zOffsets  0.276  0.276  0.553  0.829  1.106  1.382  1.659  1.935 !
            2.212  2.488  2.765  3.041  3.318  3.594  3.871  4.147 !
            4.424  4.700  4.977  5.253  5.530  5.806  6.083  6.359 !
            6.636  6.912  7.189  7.465  9.401
end hullLine
begin hullLine
station 17
  yOffsets  0.000  0.169  0.793  1.949  2.939  3.804  4.465  4.955 !
            5.322  5.603  5.819  5.988  6.122  6.229  6.313  6.379 !
            6.430  6.472  6.505  6.534  6.564  6.593  6.622  6.651 !
            6.680  6.884
  zOffsets  1.106  1.106  1.382  1.659  1.935  2.212  2.488  2.765 !
            3.041  3.318  3.594  3.871  4.147  4.424  4.700  4.977 !
            5.253  5.530  5.806  6.083  6.359  6.636  6.912  7.189 !
            7.465  9.401
end hullLine
begin hullLine
station 18
  yOffsets  0.000  0.169  2.575  3.945  4.684  5.173  5.521  5.771 !
            5.949  6.073  6.153  6.206  6.246  6.280  6.313  6.346 !
            6.379  6.412  6.446  6.479  6.512  6.545  6.578  6.611 !
            6.645  6.678  6.711
  zOffsets  2.499  2.499  2.765  3.041  3.318  3.594  3.871  4.147 !
            4.424  4.700  4.977  5.253  5.530  5.806  6.083  6.359 !
            6.636  6.912  7.189  7.465  7.742  8.018  8.295  8.571 !
            8.848  9.124  9.401
end hullLine
begin hullLine
station 19

```

```

        yOffsets  0.000  0.406  4.924  5.410  5.643  5.775  5.846  5.890  !
                5.931  5.972  6.013  6.055  6.096  6.137  6.178  6.219  !
                6.260  6.302  6.343  6.384  6.425  6.466  6.507
        zOffsets  3.611  3.611  3.871  4.147  4.424  4.700  4.977  5.253  !
                5.530  5.806  6.083  6.359  6.636  6.912  7.189  7.465  !
                7.742  8.018  8.295  8.571  8.848  9.124  9.401
end hullLine
begin hullLine
station 20
        yOffsets  0.000  2.0    4.194  5.041  5.300  5.413  5.473  5.530  !
                5.586  5.640  5.692  5.744  5.795  5.846  5.896  5.947  !
                5.998  6.049  6.101  6.151  6.201  6.251  6.302
        zOffsets  3.870  3.870  3.871  4.147  4.424  4.700  4.977  5.253  !
                5.530  5.806  6.083  6.359  6.636  6.912  7.189  7.465  !
                7.742  8.018  8.295  8.571  8.848  9.124  9.401
end hullLine
end patch
#####
begin patch
label Outer transom
normalRanges -1.0 0.9 -0.1 0.1 -0.1 0.1
areaPanelLimit 0.5
begin hullLine
        station 20
        yOffsets 6.302
        zOffsets 9.401
end hullLine
begin hullLine
        station 20
        yOffsets 6.251 6.251
        zOffsets 9.124 9.401
end hullLine
begin hullLine
        station 20
        yOffsets 5.998 5.998
        zOffsets 7.742 9.401
end hullLine
begin hullLine
        station 20
        yOffsets 5.473 5.473
        zOffsets 4.977 9.401
end hullLine
begin hullLine
        station 20
        yOffsets 5.041 5.041

```

```

        zOffsets 4.147 9.401
end hullLine
begin hullLine
    station 20
    yOffsets 4.194 4.194
    zOffsets 3.871 9.401
end hullLine
end patch
#####
begin patch
label Inner transom
normalRanges -1.0 0.9 -0.1 0.1 -0.1 0.1
areaPanelLimit 0.2
begin hullLine
    station 20
    yOffsets 4.194 4.194
    zOffsets 3.871 9.401
end hullLine
begin hullLine
    station 20
    yOffsets 2.000 2.000
    zOffsets 3.870 9.401
end hullLine
begin hullLine
    station 20
    yOffsets 0.000 0.000
    zOffsets 3.870 9.401
end hullLine
end patch
#####
begin patch
label Deck
normalRanges -0.1 0.1 -0.1 0.1 0.9 1.0
begin hullLine
    station -1.0
    yOffsets 0
    zOffsets 12.2
end hullLine
begin hullLine
    station 0
    yOffsets 2.751 0
    zOffsets 12.166 12.166
end hullLine
begin hullLine
    station 1

```

```
        yOffsets 4.849 0
        zOffsets 11.889 11.889
end hullLine
begin hullLine
    station 2
    yOffsets 5.942 0
    zOffsets 11.613 11.613
end hullLine
begin hullLine
    station 3
    yOffsets 6.504 0
    zOffsets 11.336 11.336
end hullLine
begin hullLine
    station 4
    yOffsets 6.878 0
    zOffsets 11.060 11.060
end hullLine
begin hullLine
    station 5
    yOffsets 7.113 0
    zOffsets 10.783 10.783
end hullLine
begin hullLine
    station 6
    yOffsets 7.301 0
    zOffsets 10.507 10.507
end hullLine
begin hullLine
    station 7
    yOffsets 7.411 0
    zOffsets 10.230 10.230
end hullLine
begin hullLine
    station 8
    yOffsets 7.478 0
    zOffsets 9.954 9.954
end hullLine
begin hullLine
    station 9
    yOffsets 7.521 0
    zOffsets 9.677 9.677
end hullLine
begin hullLine
    station 10
```

```
        yOffsets 7.507 0
        zOffsets 9.401 9.401
end hullLine
begin hullLine
    station 11
    yOffsets 7.507 0
    zOffsets 9.401 9.401
end hullLine
begin hullLine
    station 12
    yOffsets 7.507 0
    zOffsets 9.401 9.401
end hullLine
begin hullLine
    station 13
    yOffsets 7.437 0
    zOffsets 9.401 9.401
end hullLine
begin hullLine
    station 14
    yOffsets 7.345 0
    zOffsets 9.401 9.401
end hullLine
begin hullLine
    station 15
    yOffsets 7.214 0
    zOffsets 9.401 9.401
end hullLine
begin hullLine
    station 16
    yOffsets 7.049 0
    zOffsets 9.401 9.401
end hullLine
begin hullLine
    station 17
    yOffsets 6.884 0
    zOffsets 9.401 9.401
end hullLine
begin hullLine
    station 18
    yOffsets 6.711 0
    zOffsets 9.401 9.401
end hullLine
begin hullLine
    station 19
```

```
        yOffsets 6.507 0
        zOffsets 9.401 9.401
end hullLine
begin hullLine
    station 20
    yOffsets 6.302 0
    zOffsets 9.401 9.401
end hullLine
end patch
end patchHull3
```

A.5 Sample Output File for SM3DPanelHull3

Program SM3DPanelHull3
ShipMo3D 3.0 Version 3.0 release - 5 October 2011
Time : November-08-11 4:40:14 PM
Run label:
Generic frigate

**** ECHO OF USER INPUT ****

Run option : Full

Patch hull input file name:
genericFrigatePatchHull3.inp

Patch hull data file name:
genFrigPatchHull.bin

Wet patch hull data file name:
genFrigWetPatchHull.bin

Dry patch hull data file name:
genFrigDryPatchHull.bin

Ship Length Data
Length between perpendiculars : 120.000 m
Station of aft perpendicular : 20.000

Patch Fitting Parameters (input)
Maximum number of control segments in u direction nuMax : 40
Maximum number of control segments in v direction nvMax : 40
Nominal minimum segment length between control points : 0.100000
Maximum order of B-spline in u direction puMax : 3
Maximum order of B-spline in v direction pvMax : 3

Plot output option : File

Wet panel file name:
genFrigWetPanelHull.bin

Dry panel option : DryPanel

Dry panel file name:
genFrigDryPanelHull.bin

Water density : 1025.000 kg/m3

Ship loading condition

Draft of baseline at midships : 4.200 m
Trim of baseline by stern : 0.000 m
Height of CG above baseline : 6.000 m

Hull panelling parameters

Limit on hull panel area : 1.500000 m2
Limit on aspect ratio : 3.000000
Limit normal angles between panels : 15.0 deg

**** PATCH PROPERTIES FOR WET HULL ****

Summary of patch panels

Patch label : Smooth hull from station -1.0 to 20 (wet)
Number of panels : 600 (port side of hull)
Total panel area : 875.188179 m2
Average panel area : 1.458647 m2
Minimum panel area : 0.130543 m2
Maximum panel area : 2.005909 m2
Normal ranges (minimum and maximum)
Actual User input limits
nx -0.217 0.338 -0.500 1.000
ny -0.046 0.999 -0.050 1.000
nz -1.000 -0.048 -1.000 0.200

Patch label : Outer transom (wet)
Number of panels : 1 (port side of hull)
Total panel area : 0.147574 m2
Average panel area : 0.147574 m2
Minimum panel area : 0.147574 m2
Maximum panel area : 0.147574 m2
Normal ranges (minimum and maximum)
Actual User input limits
nx -1.000 -1.000 -1.000 0.900
ny 0.000 0.000 -0.100 0.100

nz 0.000 0.000 -0.100 0.100

Patch label : Inner transom (wet)
Number of panels : 12 (port side of hull)
Total panel area : 1.383222 m2
Average panel area : 0.115269 m2
Minimum panel area : 0.115061 m2
Maximum panel area : 0.115368 m2
Normal ranges (minimum and maximum)
Actual User input limits
nx -1.000 -1.000 -1.000 0.900
ny 0.000 0.000 -0.100 0.100
nz 0.000 0.000 -0.100 0.100

**** PROPERTIES FOR PANELLED WET HULL ****

Summary of hydrostatic properties

Number of panels on port side : 613
Total number of panels : 1226
Length between perpendiculars : 120.000 m
Draft of baseline at midships : 4.200 m
Trim of baseline by stern : 0.000 m
Beam based on maximum y value : 14.111 m
Volume : 3622.358 m3
Water density : 1025.000 kg/m3
Mass : 3712916.723463 kg
Distance from FP to X origin (m) : 61.750 m
(Origin located at LCG)
Station of X origin : 10.292
Center of buoyancy wrt waterline : -1.614 m
Wetted surface area : 1753.438 m2
Waterplane area : 1344.310 m2
X value of center of floatation : -5.022 m
Integral of waterplane area*X**2 : 1234204.219 m4
Integral of waterplane area*Y**2 : 17543.814 m4
KG, height of CG above baseline : 6.000 m
Height of CG above waterline : 1.800 m
Metacentric height from hydrostatics : 1.430 m

Calculated properties for checking of mesh

Closure error sum of area*nx : 0.055205 m2

Closure error/approx front area : 0.001180
 Profile area : 437.284026 m2
 Volumes based on integration over hull surface
 Integral of x*nx : 3619.230329 m3
 Integral of y*ny : 3622.376730 m3
 Integral of z*nz : 3622.357779 m3
 X centre of volume based on integration over hull surface
 From integral of 0.5*x*x*nx : 0.028542 m
 From integral of x*y*ny : 0.005379 m
 From integral of x*z*nz : 0.000000 m
 Z centre of volume based on integration over hull surface
 Based on integral of z*x*nx : -1.617896 m
 Based on integral of z*y*ny : -1.620029 m
 Based on integral of 0.5*z*z*nz : -1.613653 m

**** PATCH PROPERTIES FOR DRY HULL ****

Summary of patch panels

Patch label : Smooth hull from station -1.0 to 20 (dry)
 Number of panels : 20 (port side of hull)
 Total panel area : 25.483843 m2
 Average panel area : 1.274192 m2
 Minimum panel area : 0.514940 m2
 Maximum panel area : 1.805743 m2
 Normal ranges (minimum and maximum)

	Actual		User input limits	
nx	0.079	0.442	-0.500	1.000
ny	0.821	0.995	-0.050	1.000
nz	-0.433	-0.063	-1.000	0.200

Patch label : Smooth hull from station -1.0 to 20 (dry)
 Number of panels : 496 (port side of hull)
 Total panel area : 736.281122 m2
 Average panel area : 1.484438 m2
 Minimum panel area : 1.264752 m2
 Maximum panel area : 2.091978 m2
 Normal ranges (minimum and maximum)

	Actual		User input limits	
nx	-0.059	0.351	-0.500	1.000
ny	0.794	0.996	-0.050	1.000
nz	-0.559	-0.084	-1.000	0.200

Patch label : Outer transom (dry)
 Number of panels : 12 (port side of hull)
 Total panel area : 5.240685 m2
 Average panel area : 0.436724 m2
 Minimum panel area : 0.089847 m2
 Maximum panel area : 0.893025 m2
 Normal ranges (minimum and maximum)
 Actual User input limits
 nx -1.000 -1.000 -1.000 0.900
 ny 0.000 0.000 -0.100 0.100
 nz 0.000 0.000 -0.100 0.100

Patch label : Outer transom (dry)
 Number of panels : 12 (port side of hull)
 Total panel area : 3.042213 m2
 Average panel area : 0.253518 m2
 Minimum panel area : 0.146293 m2
 Maximum panel area : 0.370328 m2
 Normal ranges (minimum and maximum)
 Actual User input limits
 nx -1.000 -1.000 -1.000 0.900
 ny 0.000 0.000 -0.100 0.100
 nz 0.000 0.000 -0.100 0.100

Patch label : Inner transom (dry)
 Number of panels : 110 (port side of hull)
 Total panel area : 21.812994 m2
 Average panel area : 0.198300 m2
 Minimum panel area : 0.198300 m2
 Maximum panel area : 0.198300 m2
 Normal ranges (minimum and maximum)
 Actual User input limits
 nx -1.000 -1.000 -1.000 0.900
 ny 0.000 0.000 -0.100 0.100
 nz 0.000 0.000 -0.100 0.100

Patch label : Deck (dry)
 Number of panels : 585 (port side of hull)
 Total panel area : 833.194810 m2
 Average panel area : 1.424265 m2
 Minimum panel area : 0.092502 m2

Maximum panel area : 1.626489 m2
 Normal ranges (minimum and maximum)

	Actual	User input limits
nx	-0.054 0.018	-0.100 0.100
ny	-0.008 0.000	-0.100 0.100
nz	0.999 1.000	0.900 1.000

**** PROPERTIES FOR PANELLED DRY HULL ****

Calculated properties for checking of mesh
 Closure error sum of area*nx : 0.127951 m2
 Closure error/approx front area : 0.001131
 Profile area : 731.177920 m2
 Volumes based on integration over hull surface
 Integral of x*nx : 8621.588224 m3
 Integral of y*ny : 8633.259613 m3
 Integral of z*nz : 8633.710695 m3
 X centre of volume based on integration over hull surface
 From integral of 0.5*x*nx : 1.333577 m
 From integral of x*y*ny : 1.312184 m
 From integral of x*z*nz : 1.312310 m
 Z centre of volume based on integration over hull surface
 Based on integral of z*x*nx : 3.051918 m
 Based on integral of z*y*ny : 3.052404 m
 Based on integral of 0.5*z*nz : 3.055420 m

**** CHECK OF CLOSURE FOR COMBINED WET AND DRY HULL ****

Calculated properties for checking combined mesh of wet and dry hull
 Closure error sum of area*nx : 0.183156 m2
 Closure error/approx front area : 0.001146
 Closure error sum of area*nz : 0.099616 m2
 Closure error/approx top area : 0.000110

Computation time : 2 s

Annex B: Files for Radiation and Diffraction Computations with SM3DRadDif3

B.1 Format of Input Radiation and Diffraction File for SM3DRadDif3

Record (1), Beginning Record

“begin SM3DRadDif3” (1 character string with 2 words)

Record (2), Run Label

“label”, label (2 character strings)

“label” Record tag.

label Label for run. This can include spaces.

Record (3), Beginning of Note

Input Records (3) to (3b) can optionally be used together to give a descriptive note regarding input.

“begin note” (1 character string with 2 words)

Record (3a), Note

Input Records (3) to (3b) can optionally be used together to give a descriptive note regarding input.

noteText (character string)

noteText Text of note. Multiple lines can be entered.

Record (3b), End of Note

Input Records (3) to (3b) can optionally be used together to give a descriptive note regarding input.

“end note” (1 character string with 2 words)

Record (4), Wet Panel Hull File Name

“wetPanelFileName”, wetPanelFileName (2 character strings)

“wetPanelFileName” Record tag.

wetPanelFileName Name of file describing hull produced by SM3DPanelHull3.
This file is in .NET binary serialization format.

Record (5), Radiation and Diffraction Database File Name

“radDifDBFileName”, radDifDBFileName (2 character strings)

“radDifDBFileName” Record tag.

radDifDBFileName Name of output file of radiation and diffraction
computations in .NET binary serialization format.

Record (6), Length Data

“lengthData”, lpp, stationAP (1 character string, 2 floats)

“lengthData” Record tag.

lpp Ship length between perpendiculars (m)

stationAP Station number of the aft perpendicular. This value is typically
20.0

Note: The values in this record must agree with the values used for the wet panel hull file wetPanelFileName. Values are considered to be in agreement when they are within a tolerance of 0.001 m for length, and 0.001 for the station of the aft perpendicular. The output file from SM3DPanelHull3 gives the values of the above parameters.

Record (7), Ship Loading Condition

“loadCondition”, waterDensity, draftBlMid, trimBlStern, shipKG (1 character string, 4 floats)

“loadCondition” Record tag.

waterDensity Water density (kg/m^3).

draftBlMid Draft of baseline at midships (m).

trimBlStern Trim of baseline by stern (m).

shipKG Height of centre of gravity above baseline (m).

Note: The values in this record must agree with the values used for the wet panel hull file wetPanelFileName. Values are considered to be in agreement when they are within a tolerance of $0.001 \text{ kg}/\text{m}^3$ for density, and 0.001 m for draft, trim, and height of CG. The output file from SM3DPanelHull3 gives the values of the above parameters.

Record (8), Ship Radii of Gyration for Non-dimensional Hydrodynamic Coefficients

This record is optional. If the record is not included, then default values will be used.

“gyRadiiNom”, rollGyradius, pitchGyradius, yawGyradius (1 character string, 3 floats)

“gyRadiiOut” Record tag.

rollGyradius Ship roll gyradius (m). Default is $0.4B_{max}$, where B_{max} is determined from the maximum y value for the wet panelled hull.

pitchGyradius Ship pitch gyradius (m). Default is $0.25L$.

yawGyradius Ship yaw gyradius (m). Default is $0.25L$.

Note: These values are only used for non-dimensionalization of coefficients in the ASCII output file. These values do not affect the output dimensional values in the output database file radDifDBFileName.

Record (9), Options for Computing Hydrodynamic Coefficients

This record is optional. If the record is not included, then default values will be used.

“hydroCompOptions”, enFreqTrans, speedEnFreqMax, rAreaThreshold, rImageAreaThreshold, sourceGaussOption, fieldGalerkinOption, orderGauss (1 character string, 4 floats, 2 character strings, 1 integer)

“hydroCompOptions” Record tag.

enFreqTrans	Encounter frequency threshold for determining whether the frequency dependent Green function is determined relative to the zero frequency Green function or the infinite frequency Green function (default 0.0). A value of approximately $6\sqrt{g/L}$ is recommended.
speedEnFreqMax	Limit on U/ω_e for determining hydrodynamic forces at forward speed (default 10^6).
rAreaThreshold	Limit on $R/\sqrt{A_s}$ for exact evaluation of $1/R$ from a source panel to a field point (default 20.0).
rImageAreaThreshold	Limit on $R_1/\sqrt{A_s}$ for exact evaluation of $1/R_1$ from the image of a source panel to a field point (default 20.0).
sourceGaussOption	Option for using Gaussian quadrature from source for determining frequency dependent portion of Green function. NoSourceGauss - Centroid of source is used. SourceGauss - Multiple points on source are used (default).
fieldGalerkinOption	Option for using Galerkin method with multiple points on field panel for evaluating Green functions. NoGalerkin - Centroid of field panel is used. Galerkin - Multiple points on field panel are used (default).
orderGauss	Order of Gauss quadrature if used for source panel and/or field panel. Valid values are 1 (single point per panel), 2 (4 points, default), and 3 (9 points).

Record (10a), Encounter Frequencies

One of Record (10a) or Record (10b) must be given.

“enFreqs”, enFreqs (1 character string, array of floats)

“enFreqs” Record tag.

enFreqs Array of encounter frequencies (rad/s).

Record (10b), Encounter Frequency Range

One of Record (10a) or Record (10b) must be given.

“enFreqRange”, enFreqMin, enFreqMax, enFreqInc (1 character string, 3 floats)

“enFreqRange” Record tag.

enFreqMin Minimum encounter frequency (rad/s).

enFreqMax Maximum encounter frequency (rad/s).

enFreqInc Encounter frequency increment (rad/s).

Note: enFreqInc must be set such that there are no more than 1000 encounter frequencies.

Record (11), Encounter Frequencies for Removal

This record is optional. If this Record is omitted, then no encounter frequencies are removed.

“enFreqsRemove”, enFreqsRemove (1 character string, array of floats)

“enFreqsRemove” Record tag.

enFreqsRemove Array of encounter frequencies to be removed from values given in Records (10a) or (10b) (rad/s). This record can be used for removing irregular frequencies. If this record is not specified, then no encounter frequencies are removed unless associated matrix condition numbers exceed limits specified below.

Record (12), Beginning of Condition Number Frequency Limits

This record and the subsequent Records (12a) to (12e) are optional. If these Records are omitted, then parameters are set to defaults.

“begin”, “condLimits” (2 character strings)

Record (12a), Encounter Frequencies for Longitudinal Mode Condition Number Limits

This record is required if Record (12) has been used.

“enFreqsLongLimits”, enFreqsLongLimits (1 character strings, array of floats)

“enFreqsLongLimits” Record tag.

enFreqsLongLimits Array of encounter frequencies at which matrix condition number limits are specified for longitudinal source strengths (defaults 0.0 and 10^6).

Record (12b), Longitudinal Mode Condition Number Limits

This record is required if Record (12) has been used.

“condLimitsLong”, condLimitsLong (1 character strings, array of floats)

“condLimitsLong” Record tag.

condLimitsLong Array of longitudinal matrix condition number limits. This array must be the same length as enFreqsLongLimits in Record (12a). (defaults 10^6 and 10^6).

Record (12c), Encounter Frequencies for Lateral Mode Condition Number Limits

This record is required if Record (12) has been used.

“enFreqsLatLimits”, enFreqsLatLimits (1 character strings, array of floats)

“enFreqsLatLimits” Record tag.

enFreqsLatLimits Array of encounter frequencies at which matrix condition number limits are specified for lateral source strengths (defaults 0.0 and 10^6).

Record (12d), Lateral Mode Condition Number Limits

This record is required if Record (12) has been used.

“condLimitsLat”, condLimitsLat (1 character strings, array of floats)

“condLimitsLat” Record tag.

condLimitsLat Array of lateral matrix condition number limits. This array must be the same length as enFreqsLatLimits in Record (12c). (defaults 10^6 and 10^6).

Record (12e), End of Condition Number Frequency Limits

This record is required if Record (12) has been used.

“end”, “condLimits” (2 character strings)

Record (13a), Ship Speed Range in m/s

One of Records (13a) to (13f) must be given.

“speedRange”, speedMin, speedMax, speedInc (1 character string, 3 floats)

“speedRange” Record tag.

speedMin Minimum ship speed (m/s).

speedMax Maximum ship speed (m/s).

speedInc Increment for ship speed (m/s).

Record (13b), Ship Speeds in m/s

One of Records (13a) to (13f) must be given.

“speeds”, speeds (1 character string, array of floats)

“speeds” Record tag.

speeds Array of ship speeds (m/s).

Record (13c), Ship Speed Range in Knots

One of Records (13a) to (13f) must be given.

“speedKnotsRange”, speedKnotsMin, speedKnotsMax, speedKnotsInc (1 character string, 3 floats)

“speedKnotsRange” Record tag.

speedKnotsMin Minimum ship speed (knots).

speedKnotsMax Maximum ship speed (knots).

speedKnotsInc Increment for ship speed (knots).

Record (13d), Ship Speeds in Knots

One of Records (13a) to (13f) must be given.

“speedsKnots”, speedsKnots (1 character string, array of floats)

“speedsKnots” Record tag.

speedsKnots Array of ship speeds (knots).

Record (13e), Froude Number Range

One of Records (13a) to (13f) must be given.

“FroudeRange”, froudeMin, froudeMax, froudeInc (1 character string, 3 floats)

“FroudeRange” Record tag.

froudeMin Minimum Froude number.

froudeMax Maximum Froude number.

froudeInc Froude number increment.

Record (13f), Ship Froude Numbers

One of Records (13a) to (13f) must be given.

“Froudes”, froudes (1 character string, array of floats)

“Froudes” Record tag.

froudes Array of ship Froude numbers.

Record (14a), Range of Sea Directions Relative to the Ship

One of Records (14a) or (14b) must be given.

“seaDirDegRange”, seaDirDegMin, seaDirDegMax, seaDirDegInc (1 character string, 3 floats)

“seaDirDegRange” Record tag.

seaDirDegMin Minimum sea direction relative to ship (deg).

seaDirDegMax Maximum sea direction relative to ship (deg).

seaDirDegInc Increment sea direction relative to ship (deg).

Record (14b), Sea Directions Relative to the Ship

One of Records (14a) or (14b) must be given.

“seaDirsDeg”, seaDirsDeg (1 character string, array of floats)

“seaDirsDeg” Record tag.

seaDirsDeg Array of sea directions relative to the ship (deg) .

Record (15a), Range of Incident Wave Frequencies

One of Records (15a) or (15b) must be given.

“waveFreqRange”, waveFreqMin, waveFreqMax, waveFreqInc (1 character string, 3 floats)

“waveFreqRange” Record tag.

waveFreqMin Minimum incident wave frequency (rad/s).

waveFreqMax Maximum incident wave frequency (rad/s).

waveFreqInc Increment for incident wave frequency (rad/s).

Record (15b), Incident Wave Frequencies

One of Records (15a) or (15b) must be given.

“waveFreqs”, waveFreqs (1 character string, array of floats)

“waveFreqs” Record tag.

waveFreqs Array of increasing incident wave frequencies (rad/s).

Record (16), Option for Wave Diffraction Computations

“diffracOption”, diffracOption (2 character strings)

“diffracOption” Record tag.

diffracOption Option for completing diffraction computations.

Diffrac - Diffraction computations will be completed.

NoDiffrac - No diffraction computations.

Record (17a), Ship Speed in m/s for Output Forward Speed Radiation Coefficients

One of Records (17a), (17b), or (17c) must be given.

“speedRadCo”, speed (1 character string, 1 float)

“speedRadCo” Record tag.

speed Ship speed for output radiation coefficients at forward speed (m/s).

Record (17b), Ship Speed in Knots for Output Forward Speed Radiation Coefficients

One of Records (17a), (17b), or (17c) must be given.

“speedKnotsRadCo”, speedKnots (1 character string, 1 float)

“speedKnotsRadCo” Record tag.

speedKnots Ship speed for output radiation coefficients at forward speed (knots).

Record (17c), Ship Froude Number for Output Forward Speed Radiation Coefficients

One of Records (17a), (17b), or (17c) must be given.

“FroudeRadCo”, Froude (1 character string, 1 float)

“FroudeRadCo” Record tag.

Froude Ship Froude number for output radiation coefficients at forward speed.

Record (18), Plot Option

“plotOutOption”, plotOutOption (2 character strings)

“plotOutOption” Record tag.

plotOutOption Option for making plots of hydrodynamic coefficients.

NoPlots - No plots are produced.

ScreenFile - Plots are both plotted on the screen and to a file.

Screen - Plots are only plotted on the screen.

File - Plots are only written to a file.

Record (19), Beginning of Radiation Plot Data

This record is optional.

“begin radPlots” (1 character string with 2 words)

Note: If this record is entered, then it can be followed by an arbitrary number of repetitions of Records (19a) to (19f) giving plot parameters. Record (19g) must follow at the end of plot parameter data.

Record (19a), Radiation Plot Image File Name

This record is required if a plot is being specified.

“imageFileName”, imageFileName (2 character strings)

“imageFileName” Record tag.

imageFileName Name of output plot file.

Record (19b), Radiation Plot Image Format

This record is optional if a plot is being specified.

“imageFormat”, imageFormat (2 character strings)

“imageFormat” Record tag.

imageFormat Plot image format. Available formats are png (default) and jpg.

Record (19c), Radiation Plot Image Size

This record is optional if a plot is being specified.

“imageSize”, widthmm, heightmm (1 character string, 2 floats)

“imageSize” Record tag.

widthmm Plot width (mm). (Default 150 mm)

heightmm Plot height (mm). (Default 200 mm)

Record (19d), Option for Longitudinal and/or Lateral Modes

This record is optional if a plot is being specified.

“longLatOption”, longLatOption (2 character strings)

“longLatOption” Record tag.

longLatOption Option for plotting modes.

LongLat - Longitudinal and lateral and modes will be shown with longitudinal modes in the left column and lateral modes in the right column (default).

Long - Longitudinal modes will be shown in a single column.

Lat - Lateral modes will be shown in a single column.

Record (19e), Column Options for Longitudinal Modes

This record is optional if a plot is being specified

“longColumns”, surgeColumn, heaveColumn, pitchColumn, longConditionColumn (5 character strings)

“longColumns” Record tag.

Values for each of the following can be one of:

Left

Right

Hide

surgeColumn Column of surge graph.

heaveColumn Column of heave graph.

pitchColumn Column of pitch graph.

longConditionColumn Column of longitudinal condition number graph.

Note: The values in this record will override values set based on longLatOption in Record (19d).

Record (19f), Column Options for Lateral Modes

This record is optional if a plot is being specified.

“latColumns”, swayColumn, rollColumn, yawColumn, latConditionColumn (5 character strings)

“latColumns” Record tag.

Values for each of the following can be one of:

Left

Right

Hide

swayColumn Column of sway graph.

rollColumn Column of roll graph.

yawColumn Column of yaw graph.

latConditionColumn Column of lateral condition number graph.

Note: The values in this record will override values set based on longLatOption in Record (19d).

Record (19g), End of Radiation Plot Data

“end radPlots” (1 character string with 2 words)

Record (20), End of Input File for SM3DRadDif3

“end SM3DRadDif3” (1 character string with 2 words)

B.2 Sample Input File for SM3DRadDif3

```
begin SM3DRadDif3
label Generic frigate
wetPanelFileName genFrigWetPanelHull.bin
radDifDBFileName genFrigRadDifDB.bin
lengthData 120.000 20.000
loadCondition 1025.000 4.200 0.000 6.000
hydroCompOptions 1.5 1000000.0 20.0 20.0 SourceGauss Galerkin 2
enFreqRange 0.1 6 0.1
begin condLimits
enFreqsLongLimits 0 6
condLimitsLong 3000 3000
enFreqsLatLimits 0 6
condLimitsLat 3000 3000
end condLimits
speedKnotsRange 0 40 5
seaDirDegRange 0 180 15
waveFreqRange 0.1 2 0.1
diffracOption diffrac
FroudeRadCo 0.2
plotOutOption NoPlots
end SM3DRadDif3
```

B.3 Sample Output File for SM3DRadDif3

Program SM3DRadDif3
ShipMo3D 3.0 Version 3.0 release - 5 October 2011
Time : November-08-11 4:40:50 PM
Run label:
Generic frigate

**** ECHO OF USER INPUT ****

Input wet panel file name:
genFrigWetPanelHull.bin
Label : Generic frigate
Created : November-08-11 4:40:16 PM
Version : ShipMo3D 3.0 Version 3.0 release - 5 October 2011
Class : ShipMo3D.HullGeom.WetPanelHull

Radiation and diffraction database file name:
genFrigRadDifDB.bin

Ship Length Data
Length between perpendiculars : 120.000 m
Station of aft perpendicular : 20.000

Water density : 1025.000 kg/m3
Draft of baseline at midships : 4.200 m
Trim of baseline by stern : 0.000 m
Height of CG above baseline, KG : 6.000 m
Roll gyradius : 5.644 m (default)
Pitch gyradius : 30.000 m (default)
Yaw gyradius : 30.000 m (default)

Parameters for computing hydrodynamic coefficients (input)
Green function transition frequency : 1.500 rad/s
Limit on U/enFreq : 1000000.0
R threshold for exact integration : 20.0
R1 threshold for exact integration : 20.0
Source panel Gauss option : SourceGauss
Field panel Galerkin option : Galerkin
Order for Gauss quadrature : 2

Encounter frequency range
Minimum : 0.100 (rad/s)
Maximum : 6.000 (rad/s)

Increment : 0.100 (rad/s)

User input limits on matrix condition numbers

Matrix condition number limits for longitudinal motions

Encounter frequency (rad/s)	Condition number limit
0.000	3000.0
6.000	3000.0

Matrix condition number limits for lateral motions

Encounter frequency (rad/s)	Condition number limit
0.000	3000.0
6.000	3000.0

Speed range

Minimum : 0.000 knots

Maximum : 40.000 knots

Increment : 5.000 knots

Sea direction range

Minimum : 0.000 deg

Maximum : 180.000 deg

Increment : 15.000 deg

Incident wave frequency range

Minimum : 0.100 rad/s

Maximum : 2.000 rad/s

Increment : 0.100 rad/s

Wave diffraction computation option : Diffrac

Froude number for output forward speed radiation coefficients : 0.2

Plot option : NoPlots

**** COMPUTED HYDRODYNAMIC COEFFICIENTS****

Time for computing coefficients: 1313 s

Summary of hydrodynamic coefficients at zero speed

Added mass non-dimensionalised by modal inertia.

Damping non-dimensionalised by (modal inertia*encounter frequency).

Ship mass : 3712916.723 kg

Roll gyradius : 5.644 m

Pitch gyradius : 30.000 m

Yaw gyradius : 30.000 m

Longitudinal modes

Encounter frequency rad/s	Surge		Heave		Pitch		Condition number
	Added mass	Damping	Added mass	Damping	Added mass	Damping	
0.000	0.019	0.000	4.429	0.000	2.588	0.000	
0.100	0.020	0.000	4.645	0.247	2.618	0.007	10.1
0.200	0.020	0.000	4.777	0.888	2.706	0.032	10.3
0.300	0.022	0.001	4.543	1.650	2.877	0.116	10.8
0.400	0.024	0.003	3.972	2.248	3.095	0.370	11.5
0.500	0.025	0.007	3.239	2.544	3.178	0.843	12.8
0.600	0.023	0.011	2.520	2.518	2.956	1.363	14.5
0.700	0.019	0.014	1.987	2.251	2.483	1.697	17.2
0.800	0.015	0.013	1.692	1.938	1.951	1.729	22.0
0.900	0.013	0.012	1.524	1.692	1.589	1.542	28.3
1.000	0.011	0.011	1.397	1.489	1.412	1.360	38.4
1.100	0.010	0.011	1.307	1.300	1.282	1.228	50.5
1.200	0.009	0.010	1.250	1.134	1.182	1.095	65.3
1.300	0.008	0.009	1.214	0.987	1.116	0.980	83.5
1.400	0.008	0.008	1.196	0.857	1.068	0.875	105.3
1.500	0.007	0.008	1.181	0.757	1.018	0.801	129.6
1.600	0.007	0.007	1.182	0.658	0.994	0.720	161.9
1.700	0.007	0.007	1.186	0.570	0.979	0.649	224.6
1.800	0.007	0.006	1.151	0.468	0.965	0.584	1011.2
1.900	0.006	0.006	1.298	0.448	0.966	0.537	2066.2
2.000	0.006	0.005	1.272	0.383	0.956	0.490	1445.2
2.400	0.006	0.004	1.341	0.232	1.013	0.305	1741.8
2.500	0.006	0.003	1.356	0.204	1.022	0.286	1403.3
2.600	0.006	0.003	1.357	0.173	1.031	0.265	1586.4
2.700	0.006	0.003	1.416	0.163	1.044	0.248	2330.1
2.800	0.006	0.003	1.413	0.139	1.059	0.242	2735.3
2.900	0.006	0.003	1.442	0.127	1.053	0.222	1863.4
3.000	0.006	0.002	1.449	0.117	1.070	0.203	2364.8
3.100	0.006	0.002	1.465	0.108	1.083	0.185	2222.2
3.200	0.006	0.002	1.472	0.096	1.106	0.181	2637.9
3.300	0.006	0.002	1.487	0.082	1.107	0.174	2141.1
3.400	0.006	0.002	1.508	0.085	1.128	0.159	2390.3
3.500	0.006	0.002	1.520	0.080	1.149	0.160	2361.1
3.600	0.006	0.002	1.534	0.076	1.166	0.160	2351.3
3.700	0.007	0.001	1.546	0.075	1.195	0.161	2435.8
4.000	0.007	0.001	1.589	0.059	1.263	0.141	2165.1
4.400	0.006	0.001	1.401	0.026	0.641	0.055	1852.8
4.700	0.007	0.001	1.502	0.020	0.920	0.042	1852.5
4.800	0.007	0.000	1.507	0.020	0.929	0.045	2368.9

4.900	0.007	0.001	1.514	0.009	0.939	0.019	1955.0
5.000	0.007	0.001	1.525	0.008	0.964	0.015	1617.1
5.100	0.007	0.000	1.531	0.006	0.978	0.007	1198.2
5.200	0.007	0.000	1.537	0.003	0.992	0.000	1121.9
5.300	0.007	0.000	1.545	0.000	1.008	-0.004	916.4
5.400	0.007	0.000	1.549	0.002	1.014	0.002	704.0
5.500	0.007	0.000	1.546	0.000	1.004	-0.003	721.6
5.600	0.007	0.000	1.549	-0.006	0.997	-0.038	746.7
5.700	0.007	0.000	1.557	-0.022	1.011	-0.049	607.8
5.800	0.007	0.000	1.564	-0.024	1.037	-0.067	551.8
5.900	0.007	0.000	1.576	-0.028	1.057	-0.085	548.8
6.000	0.007	0.000	1.589	-0.030	1.097	-0.078	689.9
Infinite	0.008	0.000	1.690	0.000	1.284	0.000	

Lateral modes

Encounter frequency rad/s	Sway		Roll		Yaw		Condition number
	Added mass	Damping	Added mass	Damping	Added mass	Damping	
0.000	0.666	0.000	0.112	0.000	0.617	0.000	
0.100	0.669	0.000	0.112	0.000	0.618	0.000	12.6
0.200	0.679	0.000	0.113	0.000	0.624	0.000	12.7
0.300	0.698	0.002	0.114	0.000	0.634	0.000	12.8
0.400	0.731	0.010	0.115	0.000	0.651	0.001	13.0
0.500	0.776	0.035	0.118	0.001	0.678	0.004	13.4
0.600	0.825	0.091	0.122	0.004	0.719	0.018	13.8
0.700	0.854	0.179	0.125	0.009	0.771	0.059	14.4
0.800	0.844	0.282	0.125	0.016	0.809	0.138	15.1
0.900	0.797	0.376	0.123	0.021	0.803	0.234	16.2
1.000	0.723	0.450	0.121	0.027	0.766	0.313	17.8
1.100	0.634	0.495	0.117	0.033	0.715	0.381	20.7
1.200	0.547	0.512	0.111	0.036	0.644	0.432	24.8
1.300	0.467	0.509	0.106	0.038	0.570	0.458	30.2
1.400	0.398	0.490	0.099	0.039	0.496	0.467	39.0
1.500	0.339	0.456	0.093	0.038	0.423	0.440	69.0
1.600	0.295	0.426	0.088	0.036	0.368	0.424	79.4
1.700	0.260	0.394	0.085	0.034	0.323	0.400	91.0
1.800	0.233	0.362	0.082	0.031	0.287	0.373	102.6
1.900	0.213	0.331	0.080	0.029	0.259	0.344	113.5
2.000	0.198	0.302	0.078	0.027	0.238	0.317	121.4
2.400	0.175	0.209	0.076	0.019	0.191	0.227	1113.9
2.500	0.171	0.192	0.075	0.018	0.195	0.197	1114.8
2.600	0.164	0.171	0.075	0.016	0.191	0.185	1459.5
2.700	0.171	0.155	0.075	0.015	0.188	0.171	849.5
2.800	0.171	0.142	0.075	0.014	0.184	0.151	1231.1

2.900	0.170	0.129	0.075	0.013	0.190	0.139	983.1
3.000	0.211	0.099	0.076	0.011	0.189	0.128	2549.4
3.100	0.182	0.102	0.075	0.011	0.191	0.117	1944.2
3.200	0.183	0.099	0.076	0.011	0.197	0.106	1242.3
3.300	0.187	0.090	0.076	0.011	0.198	0.097	1191.9
3.400	0.189	0.082	0.076	0.010	0.199	0.089	1277.6
3.500	0.190	0.074	0.076	0.010	0.203	0.082	1245.3
3.600	0.189	0.062	0.076	0.009	0.205	0.075	1228.1
3.700	0.207	0.063	0.077	0.009	0.209	0.067	1210.1
4.000	0.208	0.049	0.076	0.009	0.217	0.054	2495.4
4.400	0.221	0.035	0.082	0.013	0.228	0.038	1555.6
4.700	0.236	0.020	0.066	0.002	0.234	0.028	1428.6
4.800	0.234	0.025	0.070	0.003	0.237	0.026	1109.2
4.900	0.233	0.023	0.071	0.003	0.239	0.025	1892.8
5.000	0.233	0.020	0.071	0.002	0.241	0.023	1584.4
5.100	0.235	0.012	0.072	0.001	0.242	0.021	1226.1
5.200	0.244	0.017	0.073	0.001	0.245	0.018	1108.3
5.300	0.242	0.016	0.073	0.001	0.247	0.016	889.8
5.400	0.242	0.013	0.074	0.001	0.250	0.014	941.9
5.500	0.247	0.006	0.074	0.001	0.254	0.013	775.6
5.600	0.250	0.017	0.074	0.000	0.257	0.016	581.9
5.700	0.249	0.015	0.075	0.000	0.256	0.015	563.3
5.800	0.247	0.012	0.075	-0.001	0.256	0.015	606.2
5.900	0.251	0.007	0.076	-0.001	0.257	0.013	582.9
6.000	0.255	0.012	0.077	-0.001	0.258	0.012	576.6
Infinite	0.295	0.000	0.084	0.000	0.305	0.000	

Encounter have been removed due to high condition numbers

Frequency Condition numbers (longitudinal and lateral

2.100	3164.9	143.8
2.200	4089.8	400.0
2.300	2774.4	5644.2
3.800	3404.9	1278.3
3.900	3041.3	1334.1
4.100	17229.2	1269.5
4.200	8919.8	2098.0
4.300	3214.5	2305.4
4.500	1449.2	3096.7
4.600	1379.8	3031.3

Summary of hydrodynamic coefficients at forward speed
 Added mass non-dimensionalised by modal inertia.
 Damping non-dimensionalised by (modal inertia*SQR(G/lpp)).
 Speed for hydrodynamic coefficients : 6.861 m/s, 13.322 knots
 Froude number for hydrodynamic coefficients : 0.200
 Ship mass : 3712916.723 kg
 Roll gyradius : 5.644 m
 Pitch gyradius : 30.000 m
 Yaw gyradius : 30.000 m

Surge added mass and damping at forward speed

Enfreq (rad/s)	A011	U*AUbd11	U*AUbc11	UU*AUU11	B011	U*BUbd11	U*BUbc11	UU*BUU11	Condition number
0.000	0.0194	0.0000	0.0000	Infinite	0.0000	-0.0194	0.0000	0.0000	
0.100	0.0196	0.0000	0.0000	0.0000	0.0000	-0.0194	0.0000	0.0000	10.1
0.200	0.0204	0.0000	0.0000	0.0000	0.0000	-0.0194	0.0000	0.0000	10.3
0.300	0.0219	0.0000	0.0000	0.0000	0.0006	-0.0195	0.0000	0.0000	10.8
0.400	0.0239	0.0001	0.0000	0.0000	0.0037	-0.0196	0.0000	0.0000	11.5
0.500	0.0247	0.0002	0.0000	0.0000	0.0117	-0.0197	0.0000	0.0000	12.8
0.600	0.0228	0.0003	0.0000	0.0000	0.0232	-0.0197	0.0000	0.0000	14.5
0.700	0.0187	0.0003	0.0000	0.0000	0.0332	-0.0195	0.0000	0.0000	17.2
0.800	0.0147	0.0003	0.0000	0.0000	0.0374	-0.0192	0.0000	0.0000	22.0
0.900	0.0126	0.0002	0.0000	0.0000	0.0378	-0.0192	0.0000	0.0000	28.3
1.000	0.0114	0.0002	0.0000	0.0000	0.0393	-0.0191	0.0000	0.0000	38.4
1.100	0.0101	0.0002	0.0000	0.0000	0.0406	-0.0189	0.0000	0.0000	50.5
1.200	0.0092	0.0002	0.0000	0.0000	0.0406	-0.0189	0.0000	0.0000	65.3
1.300	0.0085	0.0001	0.0000	0.0000	0.0408	-0.0189	0.0000	0.0000	83.5
1.400	0.0079	0.0001	0.0000	0.0000	0.0403	-0.0189	0.0000	0.0000	105.3
1.500	0.0074	0.0000	0.0000	0.0000	0.0404	-0.0190	0.0000	0.0000	129.6
1.600	0.0070	0.0000	0.0000	0.0000	0.0397	-0.0190	0.0000	0.0000	161.9
1.700	0.0068	0.0000	0.0000	0.0000	0.0391	-0.0191	0.0000	0.0000	224.6
1.800	0.0066	0.0000	0.0000	0.0000	0.0383	-0.0192	0.0000	0.0000	1011.2
1.900	0.0064	0.0001	0.0000	0.0000	0.0380	-0.0190	0.0000	0.0000	2066.2
2.000	0.0062	0.0001	0.0000	0.0000	0.0378	-0.0191	0.0000	0.0000	1445.2
2.400	0.0060	0.0000	0.0000	0.0000	0.0295	-0.0186	0.0000	0.0000	1741.8
2.500	0.0060	0.0000	0.0000	0.0000	0.0291	-0.0185	0.0000	0.0000	1403.3
2.600	0.0061	0.0000	0.0000	0.0000	0.0283	-0.0183	0.0000	0.0000	1586.4
2.700	0.0062	0.0000	0.0000	0.0000	0.0277	-0.0183	0.0000	0.0000	2330.1
2.800	0.0062	0.0000	0.0000	0.0000	0.0288	-0.0182	0.0000	0.0000	2735.3
2.900	0.0060	0.0000	0.0000	0.0000	0.0276	-0.0176	0.0000	0.0000	1863.4
3.000	0.0060	-0.0001	0.0000	0.0000	0.0256	-0.0181	0.0000	0.0000	2364.8
3.100	0.0061	0.0000	0.0000	0.0000	0.0230	-0.0191	0.0000	0.0000	2222.2
3.200	0.0064	0.0001	0.0000	0.0000	0.0232	-0.0181	0.0000	0.0000	2637.9
3.300	0.0062	0.0000	0.0000	0.0000	0.0239	-0.0172	0.0000	0.0000	2141.1
3.400	0.0063	-0.0001	0.0000	0.0000	0.0203	-0.0188	0.0000	0.0000	2390.3
3.500	0.0065	0.0000	0.0000	0.0000	0.0209	-0.0178	0.0000	0.0000	2361.1
3.600	0.0064	-0.0001	0.0000	0.0000	0.0208	-0.0171	0.0000	0.0000	2351.3
3.700	0.0066	0.0000	0.0000	0.0000	0.0189	-0.0182	0.0000	0.0000	2435.8
4.000	0.0070	0.0001	0.0000	0.0000	0.0182	-0.0204	0.0000	0.0000	2165.1
4.400	0.0061	0.0000	0.0000	0.0000	0.0129	-0.0261	0.0000	0.0000	1852.8
4.700	0.0065	0.0000	0.0000	0.0000	0.0094	-0.0215	0.0000	0.0000	1852.5
4.800	0.0066	0.0001	0.0000	0.0000	0.0079	-0.0207	0.0000	0.0000	2368.9
4.900	0.0066	0.0000	0.0000	0.0000	0.0133	-0.0212	0.0000	0.0000	1955.0
5.000	0.0066	0.0001	0.0000	0.0000	0.0101	-0.0209	0.0000	0.0000	1617.1
5.100	0.0066	0.0001	0.0000	0.0000	0.0086	-0.0205	0.0000	0.0000	1198.2
5.200	0.0066	0.0001	0.0000	0.0000	0.0070	-0.0200	0.0000	0.0000	1121.9
5.300	0.0067	0.0001	0.0000	0.0000	0.0050	-0.0194	0.0000	0.0000	916.4
5.400	0.0068	0.0000	0.0000	0.0000	0.0036	-0.0194	0.0000	0.0000	704.0
5.500	0.0068	0.0000	0.0000	0.0000	0.0025	-0.0201	0.0000	0.0000	721.6
5.600	0.0068	-0.0001	0.0000	0.0000	-0.0014	-0.0119	0.0000	0.0000	746.7
5.700	0.0069	0.0001	0.0000	0.0000	-0.0002	-0.0145	0.0000	0.0000	607.8
5.800	0.0071	0.0000	0.0000	0.0000	-0.0016	-0.0147	0.0000	0.0000	551.8
5.900	0.0073	-0.0002	0.0000	0.0000	-0.0025	-0.0169	0.0000	0.0000	548.8
6.000	0.0074	-0.0002	0.0000	0.0000	0.0012	-0.0216	0.0000	0.0000	689.9

Infinite 0.0082 0.0000 0.0000 0.0000 0.0000 -0.0185 0.0000 0.0000

Sway added mass and damping at forward speed

Enfreq (rad/s)	A022	U*AU _{pd} 22	U*AU _{bc} 22	UU*AU _U 22	B022	U*BU _{pd} 22	U*BU _{bc} 22	UU*BU _U 22	Condition number
0.000	0.6660	0.0000	0.0000	Infinite	0.0000	0.1958	0.0000	0.0000	
0.100	0.6690	0.0000	0.0000	0.0000	0.0000	0.1958	0.0000	0.0000	12.6
0.200	0.6790	0.0000	0.0000	0.0000	0.0001	0.1959	0.0000	0.0000	12.7
0.300	0.6984	-0.0002	0.0000	0.0000	0.0020	0.1962	0.0000	0.0000	12.8
0.400	0.7306	-0.0007	0.0000	0.0000	0.0141	0.1966	0.0000	0.0000	13.0
0.500	0.7760	-0.0018	0.0000	0.0000	0.0618	0.1965	0.0000	0.0000	13.4
0.600	0.8245	-0.0029	0.0000	0.0000	0.1904	0.1941	0.0000	0.0000	13.8
0.700	0.8535	-0.0030	0.0000	0.0000	0.4385	0.1889	0.0000	0.0000	14.4
0.800	0.8435	-0.0018	0.0000	0.0000	0.7902	0.1836	0.0000	0.0000	15.1
0.900	0.7965	-0.0006	0.0000	0.0000	1.1854	0.1798	0.0000	0.0000	16.2
1.000	0.7234	0.0008	0.0000	0.0000	1.5757	0.1749	0.0000	0.0000	17.8
1.100	0.6344	0.0030	0.0000	0.0000	1.9056	0.1737	0.0000	0.0000	20.7
1.200	0.5472	0.0041	0.0000	0.0000	2.1476	0.1765	0.0000	0.0000	24.8
1.300	0.4671	0.0050	0.0000	0.0000	2.3133	0.1788	0.0000	0.0000	30.2
1.400	0.3983	0.0054	0.0000	0.0000	2.4008	0.1837	0.0000	0.0000	39.0
1.500	0.3394	0.0061	0.0000	0.0000	2.3917	0.1807	0.0000	0.0000	69.0
1.600	0.2949	0.0059	0.0000	0.0000	2.3817	0.1855	0.0000	0.0000	79.4
1.700	0.2599	0.0057	0.0000	0.0000	2.3409	0.1895	0.0000	0.0000	91.0
1.800	0.2331	0.0053	0.0000	0.0000	2.2779	0.1933	0.0000	0.0000	102.6
1.900	0.2128	0.0050	0.0000	0.0000	2.2011	0.1966	0.0000	0.0000	113.5
2.000	0.1976	0.0047	0.0000	0.0000	2.1160	0.1996	0.0000	0.0000	121.4
2.400	0.1754	0.0034	0.0000	0.0000	1.7528	0.2092	0.0000	0.0000	1113.9
2.500	0.1708	0.0029	0.0000	0.0000	1.6757	0.2125	0.0000	0.0000	1114.8
2.600	0.1639	0.0015	0.0000	0.0000	1.5598	0.2102	0.0000	0.0000	1459.5
2.700	0.1715	0.0028	0.0000	0.0000	1.4599	0.2068	0.0000	0.0000	849.5
2.800	0.1714	0.0023	0.0000	0.0000	1.3887	0.2124	0.0000	0.0000	1231.1
2.900	0.1702	0.0019	0.0000	0.0000	1.3103	0.2134	0.0000	0.0000	983.1
3.000	0.2109	0.0018	0.0000	0.0000	1.0349	0.2085	0.0000	0.0000	2549.4
3.100	0.1820	0.0018	0.0000	0.0000	1.1011	0.2121	0.0000	0.0000	1944.2
3.200	0.1831	0.0015	0.0000	0.0000	1.1113	0.2140	0.0000	0.0000	1242.3
3.300	0.1870	0.0014	0.0000	0.0000	1.0443	0.2119	0.0000	0.0000	1191.9
3.400	0.1894	0.0014	0.0000	0.0000	0.9754	0.2127	0.0000	0.0000	1277.6
3.500	0.1903	0.0012	0.0000	0.0000	0.9022	0.2116	0.0000	0.0000	1245.3
3.600	0.1892	0.0012	0.0000	0.0000	0.7857	0.2122	0.0000	0.0000	1228.1
3.700	0.2066	0.0011	0.0000	0.0000	0.8150	0.2120	0.0000	0.0000	1210.1
4.000	0.2079	0.0009	0.0000	0.0000	0.6792	0.2127	0.0000	0.0000	2495.4
4.400	0.2214	0.0008	0.0000	0.0000	0.5459	0.2115	0.0000	0.0000	1555.6
4.700	0.2356	0.0007	0.0000	0.0000	0.3332	0.2111	0.0000	0.0000	1428.6
4.800	0.2335	0.0007	0.0000	0.0000	0.4269	0.2109	0.0000	0.0000	1109.2
4.900	0.2329	0.0007	0.0000	0.0000	0.4000	0.2114	0.0000	0.0000	1892.8
5.000	0.2330	0.0006	0.0000	0.0000	0.3471	0.2108	0.0000	0.0000	1584.4
5.100	0.2352	0.0006	0.0000	0.0000	0.2066	0.2114	0.0000	0.0000	1226.1
5.200	0.2437	0.0006	0.0000	0.0000	0.3175	0.2108	0.0000	0.0000	1108.3
5.300	0.2419	0.0004	0.0000	0.0000	0.3059	0.2103	0.0000	0.0000	889.8
5.400	0.2421	0.0004	0.0000	0.0000	0.2530	0.2114	0.0000	0.0000	941.9
5.500	0.2468	0.0004	0.0000	0.0000	0.1098	0.2146	0.0000	0.0000	775.6
5.600	0.2499	-0.0093	0.0000	0.0000	0.3243	0.2319	0.0000	0.0000	581.9
5.700	0.2491	0.0028	0.0000	0.0000	0.3019	0.2186	0.0000	0.0000	563.3
5.800	0.2474	0.0005	0.0000	0.0000	0.2377	0.2045	0.0000	0.0000	606.2
5.900	0.2506	0.0012	0.0000	0.0000	0.1442	0.2182	0.0000	0.0000	582.9
6.000	0.2549	0.0002	0.0000	0.0000	0.2515	0.2062	0.0000	0.0000	576.6
Infinite	0.2954	0.0000	0.0000	0.0000	0.0000	0.2233	0.0000	0.0000	

Heave added mass and damping at forward speed

Enfreq (rad/s)	A033	U*AU _{pd} 33	U*AU _{bc} 33	UU*AU _U 33	B033	U*BU _{pd} 33	U*BU _{bc} 33	UU*BU _U 33	Condition number
0.000	4.4295	0.0000	0.0000	Infinite	0.0000	-0.1096	0.0000	0.0000	
0.100	4.6453	-0.0002	0.0000	0.0000	0.0864	-0.1088	0.0000	0.0000	10.1
0.200	4.7767	-0.0015	0.0000	0.0000	0.6214	-0.1065	0.0000	0.0000	10.3

0.300	4.5426	-0.0042	0.0000	0.0000	1.7319	-0.1037	0.0000	0.0000	10.8
0.400	3.9721	-0.0071	0.0000	0.0000	3.1462	-0.1031	0.0000	0.0000	11.5
0.500	3.2385	-0.0076	0.0000	0.0000	4.4493	-0.1060	0.0000	0.0000	12.8
0.600	2.5199	-0.0056	0.0000	0.0000	5.2848	-0.1068	0.0000	0.0000	14.5
0.700	1.9867	-0.0051	0.0000	0.0000	5.5128	-0.1010	0.0000	0.0000	17.2
0.800	1.6919	-0.0071	0.0000	0.0000	5.4230	-0.0974	0.0000	0.0000	22.0
0.900	1.5242	-0.0080	0.0000	0.0000	5.3261	-0.0985	0.0000	0.0000	28.3
1.000	1.3967	-0.0082	0.0000	0.0000	5.2078	-0.0954	0.0000	0.0000	38.4
1.100	1.3067	-0.0101	0.0000	0.0000	5.0038	-0.0938	0.0000	0.0000	50.5
1.200	1.2496	-0.0111	0.0000	0.0000	4.7624	-0.0964	0.0000	0.0000	65.3
1.300	1.2138	-0.0122	0.0000	0.0000	4.4886	-0.0989	0.0000	0.0000	83.5
1.400	1.1959	-0.0128	0.0000	0.0000	4.1973	-0.1043	0.0000	0.0000	105.3
1.500	1.1807	-0.0128	0.0000	0.0000	3.9727	-0.1255	0.0000	0.0000	129.6
1.600	1.1817	-0.0129	0.0000	0.0000	3.6822	-0.1324	0.0000	0.0000	161.9
1.700	1.1859	-0.0129	0.0000	0.0000	3.3876	-0.1404	0.0000	0.0000	224.6
1.800	1.1507	-0.0123	0.0000	0.0000	2.9500	-0.1522	0.0000	0.0000	1011.2
1.900	1.2979	-0.0145	0.0000	0.0000	2.9801	-0.1386	0.0000	0.0000	2066.2
2.000	1.2723	-0.0134	0.0000	0.0000	2.6762	-0.1573	0.0000	0.0000	1445.2
2.400	1.3410	-0.0093	0.0000	0.0000	1.9496	-0.2021	0.0000	0.0000	1741.8
2.500	1.3562	-0.0085	0.0000	0.0000	1.7865	-0.2048	0.0000	0.0000	1403.3
2.600	1.3572	-0.0077	0.0000	0.0000	1.5710	-0.2062	0.0000	0.0000	1586.4
2.700	1.4158	-0.0071	0.0000	0.0000	1.5435	-0.2038	0.0000	0.0000	2330.1
2.800	1.4129	-0.0081	0.0000	0.0000	1.3599	-0.2088	0.0000	0.0000	2735.3
2.900	1.4415	-0.0070	0.0000	0.0000	1.2865	-0.2238	0.0000	0.0000	1863.4
3.000	1.4490	-0.0062	0.0000	0.0000	1.2261	-0.2254	0.0000	0.0000	2364.8
3.100	1.4652	-0.0050	0.0000	0.0000	1.1666	-0.2280	0.0000	0.0000	2222.2
3.200	1.4723	-0.0052	0.0000	0.0000	1.0774	-0.2204	0.0000	0.0000	2637.9
3.300	1.4871	-0.0046	0.0000	0.0000	0.9469	-0.2350	0.0000	0.0000	2141.1
3.400	1.5082	-0.0039	0.0000	0.0000	1.0126	-0.2284	0.0000	0.0000	2390.3
3.500	1.5201	-0.0044	0.0000	0.0000	0.9770	-0.2300	0.0000	0.0000	2361.1
3.600	1.5338	-0.0035	0.0000	0.0000	0.9553	-0.2373	0.0000	0.0000	2351.3
3.700	1.5461	-0.0039	0.0000	0.0000	0.9743	-0.2279	0.0000	0.0000	2435.8
4.000	1.5889	-0.0063	0.0000	0.0000	0.8237	-0.1805	0.0000	0.0000	2165.1
4.400	1.4010	-0.0005	0.0000	0.0000	0.3970	-0.2353	0.0000	0.0000	1852.8
4.700	1.5022	0.0003	0.0000	0.0000	0.3233	-0.2530	0.0000	0.0000	1852.5
4.800	1.5071	0.0003	0.0000	0.0000	0.3290	-0.2606	0.0000	0.0000	2368.9
4.900	1.5142	0.0011	0.0000	0.0000	0.1530	-0.2379	0.0000	0.0000	1955.0
5.000	1.5253	0.0005	0.0000	0.0000	0.1462	-0.2435	0.0000	0.0000	1617.1
5.100	1.5313	0.0000	0.0000	0.0000	0.0997	-0.2285	0.0000	0.0000	1198.2
5.200	1.5374	-0.0027	0.0000	0.0000	0.0459	-0.2268	0.0000	0.0000	1121.9
5.300	1.5448	-0.0060	0.0000	0.0000	0.0004	-0.2888	0.0000	0.0000	916.4
5.400	1.5495	-0.0066	0.0000	0.0000	0.0373	-0.4484	0.0000	0.0000	704.0
5.500	1.5461	0.0017	0.0000	0.0000	-0.0027	-0.6094	0.0000	0.0000	721.6
5.600	1.5486	0.0104	0.0000	0.0000	-0.1222	-0.7187	0.0000	0.0000	746.7
5.700	1.5572	0.0113	0.0000	0.0000	-0.4443	-0.3704	0.0000	0.0000	607.8
5.800	1.5637	0.0174	0.0000	0.0000	-0.4925	-0.3212	0.0000	0.0000	551.8
5.900	1.5757	0.0175	0.0000	0.0000	-0.5841	-0.2443	0.0000	0.0000	548.8
6.000	1.5887	0.0180	0.0000	0.0000	-0.6203	-0.1330	0.0000	0.0000	689.9
Infinite	1.6895	0.0000	0.0000	0.0000	0.0000	-0.1751	0.0000	0.0000	

Roll added mass and damping at forward speed									
Enfreq	A044	U*AUbd44	U*AUbc44	UU*AUU44	B044	U*BUbd44	U*BUbc44	UU*BUU44	Condition
(rad/s)									number
0.000	0.1118	0.0000	0.0000	Infinite	0.0000	0.0293	0.0000	0.0000	
0.100	0.1119	0.0000	0.0000	0.0000	0.0000	0.0294	0.0000	0.0000	12.6
0.200	0.1125	0.0000	0.0000	0.0000	0.0000	0.0295	0.0000	0.0000	12.7
0.300	0.1136	0.0000	0.0000	0.0000	0.0001	0.0296	0.0000	0.0000	12.8
0.400	0.1155	0.0002	0.0000	0.0000	0.0005	0.0298	0.0000	0.0000	13.0
0.500	0.1183	0.0003	0.0000	0.0000	0.0025	0.0302	0.0000	0.0000	13.4
0.600	0.1217	0.0005	0.0000	0.0000	0.0086	0.0313	0.0000	0.0000	13.8
0.700	0.1246	0.0004	0.0000	0.0000	0.0224	0.0331	0.0000	0.0000	14.4
0.800	0.1250	-0.0001	0.0000	0.0000	0.0439	0.0351	0.0000	0.0000	15.1
0.900	0.1233	-0.0007	0.0000	0.0000	0.0672	0.0369	0.0000	0.0000	16.2
1.000	0.1214	-0.0016	0.0000	0.0000	0.0934	0.0378	0.0000	0.0000	17.8

1.100	0.1172	-0.0021	0.0000	0.0000	0.1258	0.0368	0.0000	0.0000	20.7
1.200	0.1113	-0.0025	0.0000	0.0000	0.1515	0.0366	0.0000	0.0000	24.8
1.300	0.1055	-0.0029	0.0000	0.0000	0.1750	0.0342	0.0000	0.0000	30.2
1.400	0.0992	-0.0029	0.0000	0.0000	0.1906	0.0330	0.0000	0.0000	39.0
1.500	0.0929	-0.0027	0.0000	0.0000	0.1971	0.0274	0.0000	0.0000	69.0
1.600	0.0883	-0.0027	0.0000	0.0000	0.2010	0.0262	0.0000	0.0000	79.4
1.700	0.0846	-0.0025	0.0000	0.0000	0.2014	0.0244	0.0000	0.0000	91.0
1.800	0.0817	-0.0024	0.0000	0.0000	0.1979	0.0229	0.0000	0.0000	102.6
1.900	0.0795	-0.0023	0.0000	0.0000	0.1926	0.0217	0.0000	0.0000	113.5
2.000	0.0779	-0.0022	0.0000	0.0000	0.1863	0.0204	0.0000	0.0000	121.4
2.400	0.0757	-0.0018	0.0000	0.0000	0.1601	0.0151	0.0000	0.0000	1113.9
2.500	0.0754	-0.0016	0.0000	0.0000	0.1544	0.0138	0.0000	0.0000	1114.8
2.600	0.0750	-0.0013	0.0000	0.0000	0.1500	0.0136	0.0000	0.0000	1459.5
2.700	0.0750	-0.0015	0.0000	0.0000	0.1446	0.0121	0.0000	0.0000	849.5
2.800	0.0747	-0.0012	0.0000	0.0000	0.1378	0.0108	0.0000	0.0000	1231.1
2.900	0.0751	-0.0011	0.0000	0.0000	0.1339	0.0100	0.0000	0.0000	983.1
3.000	0.0758	-0.0010	0.0000	0.0000	0.1112	0.0098	0.0000	0.0000	2549.4
3.100	0.0752	-0.0009	0.0000	0.0000	0.1230	0.0088	0.0000	0.0000	1944.2
3.200	0.0757	-0.0007	0.0000	0.0000	0.1216	0.0086	0.0000	0.0000	1242.3
3.300	0.0758	-0.0006	0.0000	0.0000	0.1228	0.0090	0.0000	0.0000	1191.9
3.400	0.0758	-0.0006	0.0000	0.0000	0.1176	0.0083	0.0000	0.0000	1277.6
3.500	0.0761	-0.0005	0.0000	0.0000	0.1180	0.0087	0.0000	0.0000	1245.3
3.600	0.0759	-0.0005	0.0000	0.0000	0.1162	0.0083	0.0000	0.0000	1228.1
3.700	0.0767	-0.0004	0.0000	0.0000	0.1108	0.0082	0.0000	0.0000	1210.1
4.000	0.0758	0.0000	0.0000	0.0000	0.1301	0.0181	0.0000	0.0000	2495.4
4.400	0.0820	0.0002	0.0000	0.0000	0.2039	0.0020	0.0000	0.0000	1555.6
4.700	0.0660	0.0000	0.0000	0.0000	0.0409	0.0086	0.0000	0.0000	1428.6
4.800	0.0701	0.0000	0.0000	0.0000	0.0425	0.0073	0.0000	0.0000	1109.2
4.900	0.0713	0.0001	0.0000	0.0000	0.0554	0.0030	0.0000	0.0000	1892.8
5.000	0.0709	0.0002	0.0000	0.0000	0.0403	0.0108	0.0000	0.0000	1584.4
5.100	0.0720	0.0001	0.0000	0.0000	0.0222	0.0107	0.0000	0.0000	1226.1
5.200	0.0731	0.0000	0.0000	0.0000	0.0217	0.0125	0.0000	0.0000	1108.3
5.300	0.0734	-0.0006	0.0000	0.0000	0.0164	0.0156	0.0000	0.0000	889.8
5.400	0.0740	-0.0014	0.0000	0.0000	0.0132	-0.0007	0.0000	0.0000	941.9
5.500	0.0743	-0.0020	0.0000	0.0000	0.0149	-0.0514	0.0000	0.0000	775.6
5.600	0.0740	0.0021	0.0000	0.0000	0.0038	-0.1000	0.0000	0.0000	581.9
5.700	0.0749	0.0039	0.0000	0.0000	-0.0021	-0.0275	0.0000	0.0000	563.3
5.800	0.0753	0.0024	0.0000	0.0000	-0.0114	0.0019	0.0000	0.0000	606.2
5.900	0.0760	0.0029	0.0000	0.0000	-0.0193	0.0085	0.0000	0.0000	582.9
6.000	0.0769	0.0025	0.0000	0.0000	-0.0138	0.0326	0.0000	0.0000	576.6
Infinite	0.0843	0.0000	0.0000	0.0000	0.0000	0.0158	0.0000	0.0000	

Pitch added mass and damping at forward speed

Enfreq (rad/s)	A055	U*AU _{pd} 55	U*AU _{bc} 55	UU*AUU55	B055	U*BU _{pd} 55	U*BU _{bc} 55	UU*BUU55	Condition number
0.000	2.5881	0.0000	0.0000	Infinite	0.0000	-0.2925	0.7446	0.0000	
0.100	2.6175	-0.0005	-0.0946	9.7769	0.0024	-0.2891	0.7740	-0.0021	10.1
0.200	2.7061	-0.0038	-0.1700	2.4737	0.0221	-0.2779	0.7933	-0.0116	10.3
0.300	2.8769	-0.0127	-0.2111	1.1446	0.1218	-0.2585	0.7656	-0.0141	10.8
0.400	3.0954	-0.0296	-0.2177	0.6935	0.5177	-0.2372	0.6947	0.0208	11.5
0.500	3.1776	-0.0494	-0.2005	0.4716	1.4741	-0.2333	0.6019	0.1082	12.8
0.600	2.9563	-0.0587	-0.1704	0.3116	2.8604	-0.2556	0.5090	0.2090	14.5
0.700	2.4830	-0.0554	-0.1365	0.1841	4.1551	-0.2821	0.4356	0.2313	17.2
0.800	1.9511	-0.0483	-0.1076	0.1108	4.8396	-0.2884	0.3883	0.1636	22.0
0.900	1.5894	-0.0494	-0.0862	0.0819	4.8552	-0.2808	0.3595	0.0969	28.3
1.000	1.4118	-0.0527	-0.0708	0.0659	4.7584	-0.2945	0.3388	0.0688	38.4
1.100	1.2818	-0.0515	-0.0591	0.0526	4.7236	-0.3072	0.3218	0.0469	50.5
1.200	1.1822	-0.0532	-0.0497	0.0442	4.5982	-0.3172	0.3080	0.0281	65.3
1.300	1.1163	-0.0534	-0.0421	0.0378	4.4545	-0.3373	0.2973	0.0153	83.5
1.400	1.0676	-0.0538	-0.0359	0.0331	4.2840	-0.3560	0.2887	0.0049	105.3
1.500	1.0175	-0.0511	-0.0317	0.0305	4.2010	-0.4341	0.2772	-0.0005	129.6
1.600	0.9942	-0.0504	-0.0274	0.0276	4.0297	-0.4605	0.2720	-0.0057	161.9
1.700	0.9786	-0.0489	-0.0238	0.0255	3.8572	-0.4905	0.2680	-0.0087	224.6
1.800	0.9647	-0.0466	-0.0202	0.0274	3.6762	-0.5385	0.2630	-0.0045	1011.2

1.900	0.9656	-0.0458	-0.0202	0.0171	3.5715	-0.5234	0.2638	-0.0241	2066.2
2.000	0.9557	-0.0416	-0.0173	0.0182	3.4285	-0.5732	0.2596	-0.0186	1445.2
2.400	1.0128	-0.0350	-0.0097	0.0141	2.5598	-0.6608	0.2618	-0.0158	1741.8
2.500	1.0223	-0.0311	-0.0089	0.0133	2.4974	-0.6933	0.2642	-0.0146	1403.3
2.600	1.0313	-0.0275	-0.0081	0.0125	2.4141	-0.7197	0.2656	-0.0131	1586.4
2.700	1.0441	-0.0242	-0.0077	0.0118	2.3423	-0.7463	0.2737	-0.0122	2330.1
2.800	1.0591	-0.0189	-0.0076	0.0111	2.3699	-0.7571	0.2709	-0.0088	2735.3
2.900	1.0534	-0.0167	-0.0068	0.0103	2.2505	-0.7490	0.2691	-0.0088	1863.4
3.000	1.0702	-0.0150	-0.0061	0.0097	2.1314	-0.7454	0.2712	-0.0074	2364.8
3.100	1.0828	-0.0152	-0.0054	0.0092	2.0075	-0.7651	0.2761	-0.0081	2222.2
3.200	1.1063	-0.0116	-0.0054	0.0087	2.0317	-0.7849	0.2827	-0.0061	2637.9
3.300	1.1070	-0.0108	-0.0051	0.0081	2.0065	-0.7652	0.2809	-0.0062	2141.1
3.400	1.1282	-0.0110	-0.0046	0.0078	1.8933	-0.7933	0.2881	-0.0059	2390.3
3.500	1.1489	-0.0075	-0.0047	0.0074	1.9638	-0.7988	0.2953	-0.0043	2361.1
3.600	1.1658	-0.0087	-0.0047	0.0070	2.0162	-0.7909	0.3007	-0.0048	2351.3
3.700	1.1955	-0.0060	-0.0047	0.0067	2.0883	-0.8414	0.3124	-0.0035	2435.8
4.000	1.2628	-0.0175	-0.0038	0.0053	1.9711	-0.6586	0.3358	-0.0090	2165.1
4.400	0.6408	-0.0016	-0.0012	0.0041	0.8541	-0.4662	0.0463	-0.0014	1852.8
4.700	0.9198	0.0011	-0.0008	0.0040	0.6975	-0.6802	0.1715	0.0001	1852.5
4.800	0.9290	0.0007	-0.0009	0.0038	0.7553	-0.7083	0.1747	0.0000	2368.9
4.900	0.9394	0.0031	-0.0002	0.0036	0.3255	-0.6493	0.1792	0.0009	1955.0
5.000	0.9644	0.0013	-0.0001	0.0035	0.2554	-0.6796	0.1897	0.0002	1617.1
5.100	0.9779	-0.0005	0.0000	0.0033	0.1192	-0.6387	0.1950	-0.0007	1198.2
5.200	0.9917	-0.0089	0.0002	0.0032	-0.0070	-0.6388	0.2004	-0.0047	1121.9
5.300	1.0081	-0.0195	0.0003	0.0033	-0.0795	-0.8401	0.2072	-0.0095	916.4
5.400	1.0139	-0.0206	0.0001	0.0039	0.0313	-1.3050	0.2092	-0.0102	704.0
5.500	1.0044	-0.0009	0.0002	0.0044	-0.0611	-1.6718	0.2021	0.0004	721.6
5.600	0.9972	0.0485	0.0006	0.0040	-0.7486	-1.5715	0.2015	0.0092	746.7
5.700	1.0107	0.0528	0.0015	0.0031	-0.9732	-1.2659	0.2107	0.0297	607.8
5.800	1.0366	0.0552	0.0017	0.0030	-1.3509	-0.9799	0.2167	0.0272	551.8
5.900	1.0570	0.0510	0.0020	0.0026	-1.7504	-0.7436	0.2274	0.0233	548.8
6.000	1.0974	0.0471	0.0020	0.0024	-1.6358	-0.6071	0.2442	0.0237	689.9
Infinite	1.2839	0.0000	0.0000	0.0000	0.0000	-0.5455	0.3139	0.0000	

Yaw added mass and damping at forward speed

Enfreq (rad/s)	A066	U*AUbd66	U*AUbc66	UU*AUU66	B066	U*BUbd66	U*BUbc66	UU*BUU66	Condition number
0.000	0.6165	0.0000	0.0000	Infinite	0.0000	0.6074	-0.1566	0.0000	
0.100	0.6183	0.0000	0.0000	4.5098	0.0000	0.6077	-0.1571	0.0000	12.6
0.200	0.6239	0.0000	0.0000	1.1349	0.0000	0.6090	-0.1586	0.0001	12.7
0.300	0.6341	-0.0001	0.0002	0.5108	0.0001	0.6114	-0.1614	0.0006	12.8
0.400	0.6508	-0.0005	0.0007	0.2934	0.0007	0.6156	-0.1661	0.0024	13.0
0.500	0.6778	-0.0017	0.0020	0.1935	0.0065	0.6224	-0.1727	0.0071	13.4
0.600	0.7193	-0.0050	0.0044	0.1390	0.0370	0.6315	-0.1807	0.0161	13.8
0.700	0.7714	-0.0107	0.0078	0.1043	0.1437	0.6376	-0.1883	0.0291	14.4
0.800	0.8090	-0.0161	0.0115	0.0789	0.3870	0.6325	-0.1936	0.0421	15.1
0.900	0.8032	-0.0174	0.0152	0.0595	0.7370	0.6206	-0.1963	0.0497	16.2
1.000	0.7662	-0.0177	0.0191	0.0451	1.0961	0.6140	-0.1951	0.0515	17.8
1.100	0.7153	-0.0190	0.0224	0.0345	1.4672	0.6006	-0.1870	0.0496	20.7
1.200	0.6440	-0.0171	0.0245	0.0269	1.8131	0.5850	-0.1727	0.0444	24.8
1.300	0.5702	-0.0160	0.0252	0.0215	2.0813	0.5755	-0.1542	0.0388	30.2
1.400	0.4964	-0.0141	0.0245	0.0175	2.2881	0.5621	-0.1340	0.0329	39.0
1.500	0.4231	-0.0094	0.0218	0.0144	2.3111	0.5293	-0.1140	0.0268	69.0
1.600	0.3680	-0.0076	0.0198	0.0123	2.3721	0.5230	-0.0978	0.0222	79.4
1.700	0.3229	-0.0061	0.0176	0.0107	2.3774	0.5195	-0.0844	0.0182	91.0
1.800	0.2869	-0.0046	0.0154	0.0094	2.3456	0.5170	-0.0740	0.0149	102.6
1.900	0.2592	-0.0035	0.0134	0.0084	2.2883	0.5161	-0.0660	0.0122	113.5
2.000	0.2381	-0.0024	0.0116	0.0076	2.2154	0.5166	-0.0602	0.0100	121.4
2.400	0.1905	-0.0016	0.0065	0.0052	1.9024	0.5323	-0.0491	0.0026	1113.9
2.500	0.1951	0.0000	0.0057	0.0049	1.7256	0.5180	-0.0485	0.0024	1114.8
2.600	0.1915	-0.0001	0.0048	0.0046	1.6819	0.5272	-0.0456	0.0026	1459.5
2.700	0.1883	-0.0004	0.0041	0.0043	1.6176	0.5319	-0.0486	0.0016	849.5
2.800	0.1840	-0.0011	0.0035	0.0040	1.4795	0.5179	-0.0485	0.0012	1231.1
2.900	0.1900	0.0006	0.0032	0.0038	1.4131	0.5248	-0.0494	0.0009	983.1

3.000	0.1893	0.0003	0.0027	0.0034	1.3391	0.5315	-0.0496	-0.0012	2549.4
3.100	0.1914	-0.0002	0.0024	0.0033	1.2722	0.5302	-0.0510	0.0004	1944.2
3.200	0.1973	0.0005	0.0021	0.0032	1.1873	0.5279	-0.0516	0.0000	1242.3
3.300	0.1981	0.0002	0.0018	0.0030	1.1148	0.5303	-0.0525	-0.0002	1191.9
3.400	0.1993	0.0001	0.0016	0.0028	1.0594	0.5267	-0.0536	-0.0003	1277.6
3.500	0.2029	0.0004	0.0013	0.0027	1.0094	0.5298	-0.0549	-0.0003	1245.3
3.600	0.2048	0.0004	0.0012	0.0025	0.9404	0.5288	-0.0566	-0.0004	1228.1
3.700	0.2087	0.0005	0.0011	0.0024	0.8615	0.5292	-0.0562	-0.0007	1210.1
4.000	0.2172	0.0007	0.0007	0.0021	0.7531	0.5332	-0.0598	-0.0006	2495.4
4.400	0.2278	0.0008	0.0005	0.0018	0.5829	0.5310	-0.0625	-0.0006	1555.6
4.700	0.2338	0.0007	0.0004	0.0016	0.4668	0.5330	-0.0647	-0.0007	1428.6
4.800	0.2373	0.0009	0.0003	0.0015	0.4435	0.5326	-0.0652	-0.0005	1109.2
4.900	0.2393	0.0008	0.0003	0.0014	0.4211	0.5343	-0.0657	-0.0005	1892.8
5.000	0.2414	0.0008	0.0002	0.0014	0.3967	0.5338	-0.0666	-0.0005	1584.4
5.100	0.2424	0.0008	0.0002	0.0013	0.3703	0.5365	-0.0671	-0.0007	1226.1
5.200	0.2450	0.0008	0.0002	0.0013	0.3316	0.5357	-0.0669	-0.0004	1108.3
5.300	0.2470	0.0005	0.0002	0.0012	0.2955	0.5360	-0.0676	-0.0003	889.8
5.400	0.2498	0.0005	0.0001	0.0012	0.2682	0.5365	-0.0685	-0.0001	941.9
5.500	0.2542	-0.0006	0.0002	0.0009	0.2512	0.5426	-0.0694	0.0003	775.6
5.600	0.2573	0.0094	0.0002	0.0003	0.3171	0.5105	-0.0687	0.0081	581.9
5.700	0.2557	0.0027	0.0001	0.0009	0.3007	0.6037	-0.0698	-0.0033	563.3
5.800	0.2560	0.0002	0.0002	0.0010	0.2961	0.5353	-0.0700	0.0009	606.2
5.900	0.2571	0.0020	0.0001	0.0010	0.2642	0.5619	-0.0700	0.0011	582.9
6.000	0.2578	0.0003	0.0001	0.0009	0.2470	0.5513	-0.0698	0.0000	576.6
Infinite	0.3045	0.0000	0.0000	0.0000	0.0000	0.5776	-0.0796	0.0000	

This page intentionally left blank.

Annex C: Files for Panelling a Sloshing Tank with SM3DPanelSloshTank3

C.1 Format of Input File for SM3DPanelSloshTank3

Record (1), Beginning Record

“begin SM3DPanelSloshTank3” (1 character string with 2 words)

Record (2), Run Title

“label”, label (2 character strings)

“label” Record tag.

label Title for run. This can include spaces.

Record (3), Beginning of Note

Input Records (3) to (3b) can optionally be used together to give a descriptive note regarding input.

“begin note” (1 character string with 2 words)

Record (3a), Note

Input Records (3) to (3b) can optionally be used together to give a descriptive note regarding input.

noteText (character string)

noteText Text of note. Multiple lines can be entered.

Record (3b), End of Note

Input Records (3) to (3b) can optionally be used together to give a descriptive note regarding input.

“end note” (1 character string with 2 words)

Record (4), Run Type

“runOption”, runOption (2 character strings)

“runOption” Record tag.

runOption Option for run.

Full - Full run including panelling of tank.

NoPanel - No panelling of the tank. This run type can be used for checking of the patch tank.

Record (5), Patch Tank Input Option

“patchSloshTankInputOption”, patchSloshTankInputOption (2 character strings)

“patchSloshTankInputOption” Record tag.

patchSloshTankInputOption Option for run.

Box - The tank geometry is described by dimensions for a box. Record (6a) is required.

BoxNarrowMiddle - The tank geometry is described by dimensions for a box with a narrow middle portion in the horizontal plane. This type of geometry is often used for roll stabilization flume tanks. Record (7a) is required.

PatchInputFile - No panelling of the tank. This run type can be used for checking of the patch tank. Record (7b) is required.

Record (6a), Tank Box Dimensions

“boxDimensions”, lengthTank, widthTank, heightTank (1 character string, 3 floats)

“boxDimensions” Record tag.

lengthTank Length along the longitudinal direction of the ship, L_{tank} (m).

widthTank Width in the lateral direction of the ship (m).

heightTank Total height (m).

Record (7a), Dimensions of Tank Box with Narrow Middle Dimensions

“boxNarrowMiddleDimensions”, lengthTank, widthTank, heightTank
lengthMiddleTank, widthMiddleTank (1 character string, 5 floats)

“boxNarrowMiddleDimensions” Record tag.

lengthTank Length along the longitudinal direction of the ship, L_{tank} (m).

widthTank Width in the lateral direction of the ship (m).

heightTank Total height (m).

lengthMiddleTank Length along the centreline of the ship. This value must be less than lengthTank.

widthMiddleTank Lateral width at the lateral centre of the tank. This value must be less than widthTank.

Record (7b), Patch Tank Input File Name

“patchSloshTankInputFileName”, patchSloshTankInputFileName (2 character strings)

“patchSloshTankInputFileName” Record tag.

patchSloshTankInputFileName Name of input file with description of patch tank. The format of the file is given in Section C.2.

Record (8), Patch Tank Data File Name

“patchSloshTankDataFileName”, patchSloshTankDataFileName (2 character strings)

“patchSloshTankDataFileName” Record tag.

patchSloshTankDataFileName Name of file to be written with binary representation of patch tank.

Record (9), Wet Patch Tank Data File Name

“wetPatchSloshTankDataFileName”, wetPatchSloshTankDataFileName (2 character strings)

“wetPatchSloshTankDataFileName” Record tag.

wetPatchSloshTankDataFileName Name of file to be written with binary representation of wet patch tank.

Record (10), Dry Patch Tank Data File Name

“dryPatchSloshTankDataFileName”, dryPatchSloshTankDataFileName (2 character strings)

“dryPatchSloshTankDataFileName” Record tag.

dryPatchSloshTankDataFileName Name of file to be written with binary representation of dry patch tank.

Record (11), Patch Parameters for Fitting B-splines to Surfaces

This record is optional.

“patchFitParam”, nuMax, nvMax, spacingMin, puMax, pvMax (1 character string, 2 integers, 1 float, 2 integers)

“patchFitParam” Record tag.

nuMax Maximum number of control segments in u direction for fitted patch (default 40). Must be in the range $5 \leq \text{nuMax} \leq 40$.

nvMax Maximum number of control segments in v direction for fitted patch (default 40). Must be in the range $5 \leq \text{nvMax} \leq 40$.

spacingMin Minimum nominal spacing between control points on a fitted surface (default $0.001 L_{tank}$). This value must be $\leq 0.01 L_{tank}$.

puMax Maximum degree of fitted B-splines in u direction (default 3).

pvMax Maximum degree of fitted B-splines in v direction (default 3).

Record (12), Plot Output Option

This record is optional.

“plotOutOption”, plotOutOption (2 character strings)

“plotOutOption” Record tag.

plotOutOption Option for making plots.

NoPlots - No plots are produced.

ScreenFile - Plots are both plotted on the screen and to a file.

Screen - Plots are only plotted on the screen.

File - Plots are only written to a file (default).

Record (13), Beginning of Patch Tank Line Plot Data

This record is optional.

“begin patchLinePlots” (1 character string with 2 words)

Note: If this record is entered, then it can be followed by an arbitrary number of repetitions of Records (13a) to (13g) giving plot parameters. Record (13h) must follow at the end of plot parameter data.

Record (13a), Patch Tank Image File Name

This record is required if a plot is being specified.

“imageFileName”, imageFileName (2 character strings)

“imageFileName” Record tag.

imageFileName Name of output plot file.

Record (13b), Patch Tank Line Image Format

This record is optional if a plot is being specified.

“imageFormat”, imageFormat (2 character strings)

“imageFormat” Record tag.

imageFormat Plot image format. Available formats are png (default) and jpg.

Record (13c), Patch Tank Line Image Size

This record is optional if a plot is being specified.

“imageSize”, widthmm, heightmm (1 character string, 2 floats)

“imageSize” Record tag.

widthmm Plot width (mm). (Default 150 mm)

heightmm Plot height (mm). (Default 100 mm)

Record (13d), Patch Tank Line Camera Settings

This record is required if a plot is being specified.

“camera”, camPosHorAngleDeg, camPosVertAngleDeg, camViewAngleDeg (1 character string, 3 floats)

“camera” Record tag.

camPosHorAngleDeg Horizontal position (deg) of camera relative to ship (0 deg for front, 90 deg for left).

camPosVertAngleDeg Vertical position (deg) of camera relative to ship (0 deg for horizontal, 90 deg for above).

camViewAngleDeg Camera view angle (deg).

Record (13e), Patch Tank Line Lighting Settings

This record is optional if a plot is being specified.

“lighting”, ambientLightIntensity, directLightIntensity, directLightHorAngleDeg, directLightVertAngleDeg (1 character string, 3 floats)

“lighting” Record tag.

ambientLightIntensity Ambient light intensity (default 0.5).

directLightIntensity Direct light intensity (default 1.0).

directLightHorAngleDeg Horizontal position (deg) of direct light source relative to ship (0 deg for front, 90 deg for left, default 0 deg).

directLightVertAngleDeg Vertical position (deg) of direct light source relative to ship (0 deg for horizontal, 90 deg for above, default 45 deg).

Record (13f), Patch Tank Line Plot Show Starboard Option

This record is optional if a plot is being specified.

“showStarboardOption”, showStarboardOption (2 character strings)

“showStarboardOption” Record tag.

showStarboardOption Option for showing starboard portion of tank.

ShowStarboard - Both sides of tank are shown (default).

HideStarboard - Only port side of tank is shown.

Record (13g), Patch Tank Line Thicknesses

This record is optional if a plot is being specified.

“lineThicknesses”, lineThickness, edgeLineThickness (1 character string, 2 integers)

“lineThicknesses” Record tag.

lineThickness Line thickness of patch tank lines (default 3.0).

edgeLineThickness Line thickness of lines along patch edges (default 1.0).

Record (13h), End of Plot Data

This record is required if Record (13) has been entered.

“end patchLinePlots” (1 character string with 2 words)

Record (14), Beginning of Patch Tank Surface Plot Data

This record is optional.

“begin patchSurfacePlots” (1 character string with 2 words)

Note: If this record is entered, then it can be followed by an arbitrary number of repetitions of Records (14a) to (14h) giving plot parameters. Record (14i) must follow at the end of plot parameter data.

Record (14a), Patch Tank Surface Image File Name

This record is required if a plot is being specified.

“imageFileName”, imageFileName (2 character strings)

“imageFileName” Record tag.

imageFileName Name of output plot file.

Record (14b), Patch Tank Surface Image Format

This record is optional if a plot is being specified.

“imageFormat”, imageFormat (2 character strings)

“imageFormat” Record tag.

imageFormat Plot image format. Available formats are png (default) and jpg.

Record (14c), Patch Tank Surface Image Size

This record is optional if a plot is being specified.

“imageSize”, widthmm, heightmm (1 character string, 2 floats)

“imageSize” Record tag.

widthmm Plot width (mm). (Default 150 mm)

heightmm Plot height (mm). (Default 100 mm)

Record (14d), Patch Tank Surface Camera Settings

This record is required if a plot is being specified.

“camera”, camPosHorAngleDeg, camPosVertAngleDeg, camViewAngleDeg (1 character string, 3 floats)

“camera” Record tag.

camPosHorAngleDeg Horizontal position (deg) of camera relative to ship (0 deg for front, 90 deg for left).

camPosVertAngleDeg Vertical position (deg) of camera relative to ship (0 deg for horizontal, 90 deg for above).

camViewAngleDeg Camera view angle (deg).

Record (14e), Patch Tank Surface Lighting Settings

This record is optional if a plot is being specified.

“lighting”, ambientLightIntensity, directLightIntensity, directLightHorAngleDeg, directLightVertAngleDeg (1 character string, 3 floats)

“lighting”	Record tag.
ambientLightIntensity	Ambient light intensity (default 0.5).
directLightIntensity	Direct light intensity (default 1.0).
directLightHorAngleDeg	Horizontal position (deg) of direct light source relative to ship (0 deg for front, 90 deg for left, default 0 deg).
directLightVertAngleDeg	Vertical position (deg) of direct light source relative to ship (0 deg for horizontal, 90 deg for above, default 45 deg).

Record (14f), Patch Tank Surface Plot Wet/Dry Option

This record is optional if a plot is being specified.

“wetDryOption”, wetDry (2 character strings)

“wetDryOption”	Record tag.
wetDryOption	Option for tank to be displayed. Full - The full patch tank is shown (default). Wet - The trimmed wet patch tank is shown. Dry - The trimmed dry patch tank is shown.

Record (14g), Patch Tank Surface Plot Colour

This record is optional if a plot is being specified.

“patchSloshTankColour”, patchSloshTankColour (2 character strings)

“patchSloshTankColour” Record tag.

patchSloshTankColour Tank colour, which can be one of:
Multi - Each tank patch is assigned a colour (default).
Red.
Green.
Yellow.
Grey.

Record (14h), Patch Tank Surface Plot Show Starboard Option

This record is optional if a plot is being specified.

“showStarboardOption”, showStarboardOption (2 character strings)

“showStarboardOption” Record tag.

showStarboardOption Option for showing starboard portion of tank:
ShowStarboard - Both sides of tank are shown (default).
HideStarboard - Only port side of tank is shown.

Record (14i), End of Patch Tank Surface Plot Data

This record is required if Record (14) has been entered.

“end patchSurfacePlots” (1 character string with 2 words)

Record (15), Wet Panel Tank File Name

“wetPanelFileName”, wetPanelFileName (2 character strings)

“wetPanelFileName” Record tag.

wetPanelFileName Name of output file describing tank in .NET binary serialization format.

Record (16), Dry Panel Tank Option

“dryPanelOption”, dryPanelOption (2 character strings)

“dryPanelOption” Record tag.

dryPanelOption Option for panelling dry portion of tank.

DryPanel - Dry portion of tank is panelled.

NoDryPanel - Dry portion of tank is not panelled.

Note: If the option DryPanel is selected, then the input patch tank should describe a fully enclosed volume.

Record (16a), Dry Panel Tank File Name

This record is only required if dryPanelOption is set to dryPanel in Record (16).

“dryPanelFileName”, dryPanelFileName (2 character strings)

“dryPanelFileName” Record tag.

dryPanelFileName Name of output file describing tank in .NET binary serialization format.

Record (17), Fluid Density

“fluidDensity”, fluidDensity (1 character string, 1 float)

“fluidDensity” Record tag.

fluidDensity Water density (kg/m³). For fresh water, a value of 1000 kg/m³ is recommended.

Record (18), Draft and Trim

“heightFluid”, heightFluid (1 character string, 1 float)

“heightFluid” Record tag.

heightFluid Height of fluid above tank baseline. This value must be $\leq h_{tank}$, where h_{tank} is the total height of the tank.

Record (19), Tank Panel Parameters

“panelParameters”, areaPanelLimit, aspectPanelLimit,
deltaNormalPanelLimitDeg (1 character string, 3 floats)

“panelParameters”	Record tag.
areaPanelLimit	Limit on area for tank panels (m ²).
aspectPanelLimit	Limiting tank panel aspect ratio. A value of 3.0 is recommended.
deltaNormalPanelLimitDeg	Limit on normal angle between adjacent panels. A value of 15° is recommended.

Record (20), Beginning of Panelled Tank Plot Data

This record is optional.

“begin panelPlots” (1 character string with 2 words)

Note: If this record is entered, then it can be followed by an arbitrary number of repetitions of Records (20a) to (20g) giving plot parameters. Record (20h) must follow at the end of plot parameter data.

Record (20a), Panelled Tank Image File Name

This record is required if a plot is being specified.

“imageFileName”, imageFileName (2 character strings)

“imageFileName” Record tag.

imageFileName Name of output plot file.

Record (20b), Panelled Tank Image Format

This record is optional if a plot is being specified.

“imageFormat”, imageFormat (2 character strings)

“imageFormat” Record tag.

imageFormat Plot image format. Available formats are png (default) and jpg.

Record (20c), Panelled Tank Image Size

This record is optional if a plot is being specified.

“imageSize”, widthmm, heightmm (1 character string, 2 floats)

“imageSize” Record tag.

widthmm Plot width (mm). (Default 150 mm)

heightmm Plot height (mm). (Default 100 mm)

Record (20d), Panelled Tank Camera Settings

This record is required if a plot is being specified.

“camera”, camPosHorAngleDeg, camPosVertAngleDeg, camViewAngleDeg (1 character string, 3 floats)

“camera” Record tag.

camPosHorAngleDeg Horizontal position (deg) of camera relative to ship (0 deg for front, 90 deg for left).

camPosVertAngleDeg Vertical position (deg) of camera relative to ship (0 deg for horizontal, 90 deg for above).

camViewAngleDeg Camera view angle (deg).

Record (20e), Panelled Tank Lighting Settings

This record is optional if a plot is being specified.

“lighting”, ambientLightIntensity, directLightIntensity, directLightHorAngleDeg, directLightVertAngleDeg (1 character string, 3 floats)

“lighting” Record tag.

ambientLightIntensity Ambient light intensity (default 0.5).

directLightIntensity Direct light intensity (default 1.0).

directLightHorAngleDeg Horizontal position (deg) of direct light source relative to ship (0 deg for front, 90 deg for left, default 0 deg).

directLightVertAngleDeg Vertical position (deg) of direct light source relative to ship (0 deg for horizontal, 90 deg for above, default 45 deg).

Record (20f), Panel Tank Plot Options

This record is required if a plot is being specified.

“panelPlotOptions”, wetDryOption, colourTable, showStarboardOption, smoothShadeOption (5 character strings)

“panelPlotOptions”	Record tag.
wetDryOption	Option for displacing wet and/or dry tank. Wet - Wet tank only is plotted. Dry - Dry tank only is plotted. dryPanelOption must be “DryPanel” in Record (16). WetDry - Wet and dry tanks are plotted together. dryPanelOption must be “DryPanel” in Record (16).
colourTable	Colour table. Available tables are BlueGreenRedScale, RedTankYellowApp, TankLiftSurfaceProp, WetWhiteDryGrey, GreyScale, PartialGreyScale, and White.
showStarboardOption	Option for showing starboard portion of tank. ShowStarboard - Both sides of tank are shown. HideStarboard - Only port side of tank is shown.
smoothShadeOption	Option for shading of tank panels. Solid - Each panel has a constant colour based on the centroid location. Smooth - Each panel can have colour variation within the panel.

Record (20g), Panel Line Thickness

This record is optional if a plot is being specified.

“lineThickness”, lineThickness (1 character string, 1 float)

“lineThickness” Record tag.

lineThickness Line thickness of panels (default 1.0).

Record (20h), End of Panelled Tank Plot Data

“end panelPlots” (1 character string with 2 words)

Record (21), End of Input File for SM3DPanelSloshTank

“end SM3DPanelSloshTank3” (1 character string with 2 words)

C.2 Format of Input PatchSloshTank File

Record (1), Beginning Record

“begin patchSloshTank3” (1 character string with 2 words)

Record (2), Patch Tank Label

“label”, label (2 character strings)

“label” Record tag.

label Label for patch sloshing tank. This can include spaces.

Record (3), Dimension Data

“dimensions”, length, width, height (1 character string, 3 floats)

“dimensions” Record tag.

length Tank length (m)

width Tank width (m)

height Tank height (m)

Record (4), Scaling Parameters for Offsets

This record is optional.

“scaleXYZ”, xScale, yScale, zScale (1 character string, 3 floats)

“scaleXYZ” Record tag.

xScale Scale factor for input x offsets. A default of 1.0 is used if this record is omitted.

yScale Scale factor for input y offsets. A default of 1.0 is used if this record is omitted.

zScale Scale factor for input z offsets. A default of 1.0 is used if this record is omitted.

Record (5), Beginning of Data for Tank Patch

This record is followed by repeated series of Records (5a) to (5d5), finishing with Record (5e). These groups of records can be repeated to describe an arbitrary number of patches encompassing the ship tank.

“begin patch” (1 character string with 2 words)

Record (5a), Patch Label

“label”, label (2 character strings)

“label” Record tag.

label Label for patch. This can include spaces.

Record (5b), Normal Ranges for Checking of Tank Panelling

“normalRanges”, nxMinLimit, nxMaxLimit, nyMinLimit, nyMaxLimit, nzMinLimit, nzMaxLimit (1 character string, 6 floats)

“normalRanges” Record tag.

nxMinLimit Minimum x normal component for patch surface.

nxMaxLimit Maximum x normal component for patch surface.

nyMinLimit Minimum y normal component for patch surface.

nyMaxLimit Maximum y normal component for patch surface.

nzMinLimit Minimum z normal component for patch surface.

nzMaxLimit Maximum z normal component for patch surface.

Note: The input normal ranges are intended to be broad ranges used for checking that generated panels aren't pointing in the wrong direction. Patch tank normals point outward from the tank.

Record (5c), Limit on Maximum Area for Panels on Patch

This record is optional

“areaPanelLimit”, areaPanelLimit (1 character string, 1 float)

“areaPanelLimit” Record tag.

areaPanelLimit Limit of maximum panel area on patch. A default of 10^{99} is used if this record is omitted. This record can be used for areas requiring a finer mesh size than the remainder of the tank.

Record (5d), Beginning of Tank Line Data

A patch is described by repeated series of Records (5d) to (5d5) representing tank lines. A patch must consist of at least 2 tank lines.

“begin tankLine” (1 character string with 2 words)

Record (5d1), X coordinate for Tank Line Offsets

Record (5d) must be followed by either Record (5d1) or Record (5d2). If Record (5d1) is used, then all offsets on a tank line must have the same x coordinate.

“xOffset”, station (1 character string, 1 float)

“xOffset” Record tag.

xOffset x_t coordinate for all offsets on tank line. The x_t coordinates are local tank coordinates, increasing in the forward direction.

Record (5d2), X coordinates for Tank Line Offsets

Record (5d) must be followed by either Record (5d1) or Record (5d2).

“x”, station (1 character string, nOffset floats)

“xOffsets” Record tag.

xOffsets Array of x_t coordinates for offsets on tank line. The x_t coordinates are local tank coordinates, increasing in the forward direction.

Record (5d3), Y Offsets for Tank Line

“yOffsets”, yOffsets (1 character string, nOffset floats)

“yOffsets” Record tag.

yOffsets Array of nOffset y_t offsets, where nOffset is the number of offsets on the tank line. It is assumed that the tank is located on the ship centreline and is symmetrical about the y axis.

Record (5d4), Z Offsets for Tank Line

“zOffsets”, zOffsets (1 character string, nOffset floats)

“zOffsets” Record tag.

zOffsets Array of nOffset z offsets relative to the baseline, where nOffset is the number of offsets on the tank line.

Note: Records (5d3) and (5d4) (and Record (5d2) if used) must contain data for the same number of offsets.

Record (5d5), End of Data for Tank Line

“end tankLine” (1 character string with 2 words)

Record (5e), End of Data for Patch

“end patch” (1 character string with 2 words)

Record (6), End of Data for Patch Sloshing Tank

“end patchSloshTank3” (1 character string with 2 words)

C.3 Sample Input File for SM3DPanelSloshTank3

```
begin SM3DPanelSloshTank3
label Cube slosh tank 4 m x 4 m x 2 m
runOption Full
patchSloshTankInputOption Box
boxDimensions 4 4 4
patchSloshTankDataFileName cube4mPatchSloshTank.bin
wetPatchSloshTankDataFileName cube4mWetPatchSloshTank.bin
dryPatchSloshTankDataFileName cube4mDryPatchSloshTank.bin
patchFitParam 40 40 0.01 3 3
wetPanelFileName cube4mWetPanelSloshTank.bin
dryPanelOption DryPanel
dryPanelFileName cube4mDryPanelSloshTank.bin
fluidDensity 1000.000
heightFluid 2.000
panelParameters 0.100000 3.000 15.000
end SM3DPanelSloshTank3
```

C.4 Sample Patch Tank Input File for SM3DPanelSloshTank3

```
begin patchSloshTank3
label 4 m x 4 m x 4m cube sloshing tank
dimensions 4.0 4.0 4.0
#####
begin patch
label Front
normalRanges 0.9 1.0 -0.1 0.1 -0.1 1.0
begin tankLine
    xOffsets 2.0 2.0
    yOffsets 0.0 0.0
    zOffsets 0.0 4.0
end hullLine
begin tankLine
    xOffsets 2.0 2.0
    yOffsets 4.0 4.0
    zOffsets 0.0 4.0
end tankLine
end patch
#####
begin patch
label Port side
normalRanges -0.1 0.1 0.9 1.0 -0.1 1.0
begin tankLine
    xOffsets 2.0 2.0
    yOffsets 2.0 2.0
    zOffsets 0.0 4.0
end hullLine
begin tankLine
    xOffsets -2.0 -2.0
    yOffsets 2.0 2.0
    zOffsets 0.0 4.0
end tankLine
end patch
#####
begin patch
label Back
normalRanges -1.0 -0.9 -0.1 0.1 -0.1 1.0
begin tankLine
    xOffsets -2.0 -2.0
```

```

        yOffsets 2.0 2.0
        zOffsets 0.0 4.0
end hullLine
begin tankLine
    xOffsets -2.0 -2.0
    yOffsets 0.0 0.0
    zOffsets 0.0 4.0
end tankLine
end patch
#####
begin patch
label Bottom
normalRanges -0.1 0.1 -0.1 1.0 -1.0 -0.9
begin tankLine
    xOffsets 2.0 2.0
    yOffsets 0.0 2.0
    zOffsets 0.0 0.0
end hullLine
begin tankLine
    xOffsets -2.0 -2.0
    yOffsets 0.0 2.0
    zOffsets 0.0 0.0
end tankLine
end patch
#####
begin patch
label Top
normalRanges -0.1 0.1 -0.1 1.0 0.9 1.0
begin tankLine
    xOffsets 2.0 2.0
    yOffsets 2.0 0.0
    zOffsets 4.0 4.0
end hullLine
begin tankLine
    xOffsets -2.0 -2.0
    yOffsets 2.0 0.0
    zOffsets 4.0 4.0
end tankLine
end patch
#####33
end patchSloshTank3

```

C.5 Sample Output File for SM3DPanelSloshTank3

Program SM3DPanelSloshTank3
ShipMo3D 3.0 Version 3.0 release - 5 October 2011
Time : November-09-11 8:31:29 AM
Run label:
Cube slosh tank 4 m x 4 m x 2 m

**** ECHO OF USER INPUT ****

Run option : Full

Patch tank input option : Box
Input dimensions for box-shaped tank
Length : 4.000 m
Width : 4.000 m
Height : 4.000 m

Patch tank data file name:
cube4mPatchSloshTank.bin

Wet patch tank data file name:
cube4mWetPatchSloshTank.bin

Dry patch tank data file name:
cube4mDryPatchSloshTank.bin

Patch Fitting Parameters (input)
Maximum number of control segments in u direction nuMax : 40
Maximum number of control segments in v direction nvMax : 40
Nominal minimum segment length between control points : 0.010000
Maximum order of B-spline in u direction puMax : 3
Maximum order of B-spline in v direction pvMax : 3

Plot output option : File

Wet panel file name:
cube4mWetPanelSloshTank.bin

Dry panel option : DryPanel

Dry panel file name:
cube4mDryPanelSloshTank.bin

Fluid density : 1000.000 kg/m3
Height of fluid : 2.000 m

Tank panelling parameters
Limit on tank panel area : 0.100000 m2
Limit on aspect ratio : 3.000000
Limit normal angles between panels : 15.0 deg

**** PATCH PROPERTIES FOR WET TANK ****

Summary of slosh tank patch exterior panels

Patch label : Bottom (wet)
Number of panels : 88 (port side of hull)
Total panel area : 8.000000 m2
Average panel area : 0.090909 m2
Minimum panel area : 0.090909 m2
Maximum panel area : 0.090909 m2
Normal ranges (minimum and maximum)

	Actual		User input limits	
nx	0.000	0.000	-0.010	0.010
ny	0.000	0.000	-0.010	0.010
nz	-1.000	-1.000	-1.000	-0.990

Patch label : Front (wet)
Number of panels : 42 (port side of hull)
Total panel area : 4.000000 m2
Average panel area : 0.095238 m2
Minimum panel area : 0.095238 m2
Maximum panel area : 0.095238 m2
Normal ranges (minimum and maximum)

	Actual		User input limits	
nx	1.000	1.000	0.990	1.000
ny	0.000	0.000	-0.010	0.010
nz	0.000	0.000	-0.010	0.010

Patch label : Side (wet)
Number of panels : 88 (port side of hull)
Total panel area : 8.000000 m2

Calculated properties for checking of mesh

Closure error sum of area*nx : 0.000000 m2
 Closure error/approx front area : 0.000000
 Profile area : 8.000000 m2

Volumes based on integration over tank interior surface

Integral of x*nx : 32.000000 m3
 Integral of y*ny : 32.000000 m3
 Integral of z*nz : 32.000000 m3

X centre of volume based on integration over tank interior surface

From integral of $-0.5*x*x*nx$: 0.000000 m
 From integral of $-x*y*ny$: 0.000000 m
 From integral of $-x*z*nz$: 0.000000 m

Z centre of volume based on integration over tank interior surface

Based on integral of $z*x*nx$: 1.000000 m
 Based on integral of $z*y*ny$: 1.000000 m
 Based on integral of $0.5*z*z*nz$: -1.000000 m

**** PATCH PROPERTIES FOR DRY TANK ****

Summary of slosh tank patch exterior panels

Patch label : Front (dry)

Number of panels : 42 (port side of hull)

Total panel area : 4.000000 m2

Average panel area : 0.095238 m2

Minimum panel area : 0.095238 m2

Maximum panel area : 0.095238 m2

Normal ranges (minimum and maximum)

	Actual		User input limits	
nx	1.000	1.000	0.990	1.000
ny	0.000	0.000	-0.010	0.010
nz	0.000	0.000	-0.010	0.010

Patch label : Side (dry)

Number of panels : 88 (port side of hull)

Total panel area : 8.000000 m2

Average panel area : 0.090909 m2

Minimum panel area : 0.090909 m2

Maximum panel area : 0.090909 m2

Normal ranges (minimum and maximum)

	Actual		User input limits	
nx	1.000	1.000	0.990	1.000
ny	0.000	0.000	-0.010	0.010
nz	0.000	0.000	-0.010	0.010

```

nx 0.000 0.000 -0.010 0.010
ny 1.000 1.000 0.990 1.000
nz 0.000 0.000 -0.010 0.010

```

```

Patch label      : Aft (dry)
Number of panels : 42 (port side of hull)
Total panel area : 4.000000 m2
Average panel area : 0.095238 m2
Minimum panel area : 0.095238 m2
Maximum panel area : 0.095238 m2

```

```

Normal ranges (minimum and maximum)
      Actual      User input limits
nx -1.000 -1.000 -1.000 -0.990
ny 0.000 0.000 -0.010 0.001
nz 0.000 0.000 -0.010 0.010

```

```

Patch label      : Top (dry)
Number of panels : 88 (port side of hull)
Total panel area : 8.000000 m2
Average panel area : 0.090909 m2
Minimum panel area : 0.090909 m2
Maximum panel area : 0.090909 m2

```

```

Normal ranges (minimum and maximum)
      Actual      User input limits
nx 0.000 0.000 -0.010 0.010
ny 0.000 0.000 -0.010 0.010
nz 1.000 1.000 0.990 1.000

```

**** PROPERTIES FOR PANELLED DRY TANK ****

```

Calculated properties for checking of mesh
Closure error sum of area*nx      : 0.000000 m2
Closure error/approx front area   : 0.000000
Profile area                       : 8.000000 m2
Volumes based on integration over tank interior surface
Integral of x*nx                   : 32.000000 m3
Integral of y*ny                   : 32.000000 m3
Integral of z*nz                   : 32.000000 m3
X centre of volume based on integration over tank interior surface
From integral of -0.5*x*x*nx       : 0.000000 m
From integral of -x*y*ny           : 0.000000 m

```

From integral of $-x*z*nz$: 0.000000 m
Z centre of volume based on integration over tank interior surface
Based on integral of $z*x*nx$: -1.000000 m
Based on integral of $z*y*ny$: -1.000000 m
Based on integral of $0.5*z*z*nz$: 1.000000 m

**** CHECK OF CLOSURE FOR COMBINED WET AND DRY HULL ****

Calculated properties for checking combined mesh of wet and dry
slosh tank interior

Closure error sum of $area*nx$: 0.000000 m2
Closure error/approx front area : 0.000000
Closure error sum of $area*nz$: 0.000000 m2
Closure error/approx top area : 0.000000

Computation time : 2 s

Annex D: Files for Sloshing Tank Radiation Computations with SM3DRadSloshTank3

D.1 Format of Input Sloshing Tank Radiation File for SM3DRadSloshTank3

Record (1), Beginning Record

“begin SM3DRadSloshTank3” (1 character string with 2 words)

Record (2), Run Label

“label”, label (2 character strings)

“label” Record tag.

label Label for run. This can include spaces.

Record (3), Beginning of Note

Input Records (3) to (3b) can optionally be used together to give a descriptive note regarding input.

“begin note” (1 character string with 2 words)

Record (3a), Note

Input Records (3) to (3b) can optionally be used together to give a descriptive note regarding input.

noteText (character string)

noteText Text of note. Multiple lines can be entered.

Record (3b), End of Note

Input Records (3) to (3b) can optionally be used together to give a descriptive note regarding input.

“end note” (1 character string with 2 words)

Record (4), Wet Panel Tank File Name

“wetPanelTankFileName”, wetPanelTankFileName (2 character strings)

“wetPanelTankFileName” Record tag.

wetPanelTankFileName Name of file describing wet panelled tank produced by SM3DPanelSloshTank3. This file is in .NET binary serialization format.

Record (5), Sloshing Tank Radiation Database File Name

“sloshTankRadDBFileName”, sloshTankRadDBFileName (2 character strings)

“sloshTankRadDBFileName” Record tag.

sloshTankRadDBFileName Name of output file of sloshing tank radiation computations in .NET binary serialization format.

Record (6), Fluid Flow Damping Factor

“dampingFactor”, dampingFactorPeak, enFreqLowerDampingPeak, enFreqUpperDampingPeak (1 character string, 3 floats)

“dampingFactor” Record tag.

dampingFactorPeak Peak damping factor for fluid flow within tank. This factor can be set to a value greater than zero to approximate viscous flow effects. A value of 0.10 is recommended if no data are available to justify other values.

enFreqLowerDampingPeak Lower encounter frequency (rad/s) at which fluid damping has its peak. Below this frequency, the damping factor is proportional to ω_e , wave encounter frequency.

enFreqUpperDampingPeak Upper encounter frequency (rad/s) at which fluid damping has its peak. Above this frequency, the damping factor is proportional to $1/\omega_e^2$.

Record (7), Options for Computing Hydrodynamic Coefficients

This record is optional. If the record is not included, then default values will be used.

“hydroCompOptions”, enFreqTrans, rAreaThreshold, rImageAreaThreshold, sourceGaussOption, fieldGalerkinOption, orderGauss (1 character string, 3 floats, 2 character strings, 1 integer)

“hydroCompOptions” Record tag.

enFreqTrans	Encounter frequency threshold for determining whether the frequency dependent Green function is determined relative to the zero frequency Green function or the infinite frequency Green function (default 0.0).
rAreaThreshold	Limit on $R/\sqrt{A_s}$ for exact evaluation of $1/R$ from a source panel to a field point (default 20.0).
rImageAreaThreshold	Limit on $R_1/\sqrt{A_s}$ for exact evaluation of $1/R_1$ from the image of a source panel to a field point (default 20.0).
sourceGaussOption	Option for using Gaussian quadrature from source for determining frequency dependent portion of Green function. NoSourceGauss - Centroid of source is used. SourceGauss - Multiple points on source are used (default).
fieldGalerkinOption	Option for using Galerkin method with multiple points on field panel for evaluating Green functions. NoGalerkin - Centroid of field panel is used. Galerkin - Multiple points on field panel are used (default).
orderGauss	Order of Gauss quadrature if used for source panel and/or field panel. Valid values are 1 (single point per panel), 2 (4 points, default), and 3 (9 points).

Record (8a), Encounter Frequencies

One of Record (8a) or Record (8b) must be given.

“enFreqs”, enFreqs (1 character string, array of floats)

“enFreqs” Record tag.

enFreqs Array of encounter frequencies (rad/s).

Record (8b), Encounter Frequency Range

One of Record (8a) or Record (8b) must be given.

“enFreqRange”, enFreqMin, enFreqMax, enFreqInc (1 character string, 3 floats)

“enFreqRange” Record tag.

enFreqMin Minimum encounter frequency (rad/s).

enFreqMax Maximum encounter frequency (rad/s).

enFreqInc Encounter frequency increment (rad/s).

Note: enFreqInc must be set such that there are no more than 1000 encounter frequencies.

Record (9), Encounter Frequencies for Removal

This record is optional. If this Record is omitted, then no encounter frequencies are removed.

“enFreqsRemove”, enFreqsRemove (1 character string, array of floats)

“enFreqsRemove” Record tag.

enFreqsRemove Array of encounter frequencies to be removed from values given in Records (8a) or (8b) (rad/s). This record can be used for removing irregular frequencies. If this record is not specified, then no encounter frequencies are removed unless associated matrix condition numbers exceed limits specified below.

Record (10), Beginning of Condition Number Frequency Limits

This record and the subsequent Records (10a) to (10e) are optional. If these Records are omitted, then parameters are set to defaults.

“begin”, “condLimits” (2 character strings)

Record (10a), Encounter Frequencies for Longitudinal Mode Condition Number Limits

This record is required if Record (10) has been used.

“enFreqsLongLimits”, enFreqsLongLimits (1 character strings, array of floats)

“enFreqsLongLimits” Record tag.

enFreqsLongLimits Array of encounter frequencies at which matrix condition number limits are specified for longitudinal source strengths (defaults 0.0 and 10^6).

Record (10b), Longitudinal Mode Condition Number Limits

This record is required if Record (10) has been used.

“condLimitsLong”, condLimitsLong (1 character strings, array of floats)

“condLimitsLong” Record tag.

condLimitsLong Array of longitudinal matrix condition number limits. This array must be the same length as enFreqsLongLimits in Record (10a). (defaults 10^6 and 10^6).

Record (10c), Encounter Frequencies for Lateral Mode Condition Number Limits

This record is required if Record (10) has been used.

“enFreqsLatLimits”, enFreqsLatLimits (1 character strings, array of floats)

“enFreqsLatLimits” Record tag.

enFreqsLatLimits Array of encounter frequencies at which matrix condition number limits are specified for lateral source strengths (defaults 0.0 and 10^6).

Record (10d), Lateral Mode Condition Number Limits

This record is required if Record (10) has been used.

“condLimitsLat”, condLimitsLat (1 character strings, array of floats)

“condLimitsLat” Record tag.

condLimitsLat Array of lateral matrix condition number limits. This array must be the same length as enFreqsLatLimits in Record (10c). (defaults 10^6 and 10^6).

Record (10e), End of Condition Number Frequency Limits

This record is required if Record (10) has been used.

“end”, “condLimits” (2 character strings)

Record (11), Time Increment and Maximum Value for Sloshing Tank Retardation Forces

“tRetardIncMax”, tRetardInc, tRetardMax (1 character string, 2 floats)

“tRetardIncMax” Record tag.

tRetardInc Time increment for tank sloshing retardation forces (s).

tRetardMax Maximum time for tank sloshing retardation forces (s).

Record (12), Encounter Frequency Increment and Maximum Value for Integration of Sloshing Tank Retardation Functions

“enFreqIntegrateIncMax”, enFreqIntegrateInc, enFreqIntegrateMax (1 character string, 2 floats)

“enFreqIntegrateIncMax” Record tag.

enFreqIntegrateInc Increment of encounter frequency for computation of retardation forces using integration of frequency domain coefficients.

enFreqIntegrateMax Maximum encounter frequency for computation of retardation forces using integration of frequency domain coefficients. This value should typically correspond with the maximum encounter frequency in the sloshing tank radiation database.

Record (13), Retardation Function Correction Option for Maximum Time Delay

“tRetardMaxCorrectionOption”, tRetardMaxCorrectionOption (2 character strings)

“tRetardMaxCorrectionOption” Record tag.

TRetardMaxCorrection Retardation functions are multiplied by $(1 - \tau/\tau_{max})$, which gives better results at lower frequencies (recommended).

NoTRetardMaxCorrection Retardation functions are not corrected.

Record (14), Retardation Function Output Option

“outRetardOption”, outRetardOption (2 character strings)

“outRetardOption” Record tag.

outRetardOption Retardation functions are given as a table in output file.
No retardation functions are given in output file.

Record (15), Plot Option

“plotOutOption”, plotOutOption (2 character strings)

“plotOutOption” Record tag.

plotOutOption Option for making plots of hydrodynamic coefficients.
NoPlots - No plots are produced.
ScreenFile - Plots are both plotted on the screen and to a file.
Screen - Plots are only plotted on the screen.
File - Plots are only written to a file.

Record (16), Beginning of Radiation Plot Data

This record is optional.

“begin sloshTankRadPlots” (1 character string with 2 words)

Note: If this record is entered, then it can be followed by an arbitrary number of repetitions of Records (16a) to (16f) giving plot parameters. Record (16g) must follow at the end of plot parameter data.

Record (16a), Radiation Plot Image File Name

This record is required if a plot is being specified.

“imageFileName”, imageFileName (2 character strings)

“imageFileName” Record tag.

imageFileName Name of output plot file.

Record (16b), Radiation Plot Image Format

This record is optional if a plot is being specified.

“imageFormat”, imageFormat (2 character strings)

“imageFormat” Record tag.

imageFormat Plot image format. Available formats are png (default) and jpg.

Record (16c), Radiation Plot Image Size

This record is optional if a plot is being specified.

“imageSize”, widthmm, heightmm (1 character string, 2 floats)

“imageSize” Record tag.

widthmm Plot width (mm). (Default 150 mm)

heightmm Plot height (mm). (Default 200 mm)

Record (16d), Option for Longitudinal and/or Lateral Modes

This record is optional if a plot is being specified.

“longLatOption”, longLatOption (2 character strings)

“longLatOption” Record tag.

longLatOption Option for plotting modes.

LongLat - Longitudinal and lateral and modes will be shown with longitudinal modes in the left column and lateral modes in the right column (default).

Long - Longitudinal modes will be shown in a single column.

Lat - Lateral modes will be shown in a single column.

Record (16e), Column Options for Longitudinal Modes

This record is optional if a plot is being specified

“longColumns”, surgeColumn, pitchColumn (5 character strings)

“longColumns” Record tag.

Values for each of the following can be one of:

Left

Right

Hide

surgeColumn Column of surge graph.

pitchColumn Column of pitch graph.

longConditionColumn Column of longitudinal condition number graph.

Note: The values in this record will override values set based on longLatOption in Record (16d).

Record (16f), Column Options for Lateral Modes

This record is optional if a plot is being specified.

“latColumns”, swayColumn, rollColumn, yawColumn, latConditionColumn (5 character strings)

“latColumns” Record tag.

Values for each of the following can be one of:

Left

Right

Hide

swayColumn Column of sway graph.

rollColumn Column of roll graph.

yawColumn Column of yaw graph.

latConditionColumn Column of lateral condition number graph.

Note: The values in this record will override values set based on longLatOption in Record (16d).

Record (16g), End of Slosh Tank Radiation Plot Data

“end sloshTankRadPlots” (1 character string with 2 words)

Record (17), Beginning of Retardation Plot Data

This record is optional.

“begin sloshTankRetardPlots” (1 character string with 2 words)

Note: If this record is entered, then it can be followed by an arbitrary number of repetitions of Records (17a) to (17f) giving plot parameters. Record (17g) must follow at the end of plot parameter data.

Record (17a), Retardation Plot Image File Name

This record is required if a plot is being specified.

“imageFileName”, imageFileName (2 character strings)

“imageFileName” Record tag.

imageFileName Name of output plot file.

Record (17b), Retardation Plot Image Format

This record is optional if a plot is being specified.

“imageFormat”, imageFormat (2 character strings)

“imageFormat” Record tag.

imageFormat Plot image format. Available formats are png (default) and jpg.

Record (17c), Retardation Plot Image Size

This record is optional if a plot is being specified.

“imageSize”, widthmm, heightmm (1 character string, 2 floats)

“imageSize” Record tag.

widthmm Plot width (mm). (Default 150 mm)

heightmm Plot height (mm). (Default 200 mm)

Record (17d), Option for Longitudinal and/or Lateral Modes

This record is optional if a plot is being specified.

“longLatOption”, longLatOption (2 character strings)

“longLatOption” Record tag.

longLatOption Option for plotting modes.

LongLat - Longitudinal and lateral and modes will be shown with longitudinal modes in the left column and lateral modes in the right column (default).

Long - Longitudinal modes will be shown in a single column.

Lat - Lateral modes will be shown in a single column.

Record (17e), Column Options for Longitudinal Modes

This record is optional if a plot is being specified

“longColumns”, surgeColumn, pitchColumn (3 character strings)

“longColumns” Record tag.

Values for each of the following can be one of:

Left

Right

Hide

surgeColumn Column of surge graph.

pitchColumn Column of pitch graph.

Note: The values in this record will override values set based on longLatOption in Record (17d).

Record (17f), Column Options for Lateral Modes

This record is optional if a plot is being specified.

“latColumns”, swayColumn, rollColumn, yawColumn (4 character strings)

“latColumns” Record tag.

Values for each of the following can be one of:

Left

Right

Hide

swayColumn Column of sway graph.

rollColumn Column of roll graph.

yawColumn Column of yaw graph.

Note: The values in this record will override values set based on longLatOption in Record (17d).

Record (17g), End of Slosh Tank Retardation Plot Data

“end sloshTankRetardPlots” (1 character string with 2 words)

Record (18), End of Input File for SM3DRadSloshTank3

“end SM3DRadSloshTank3” (1 character string with 2 words)

D.2 Sample Input File for SM3DRadSloshTank3

```
begin SM3DRadSloshTank3
label Cube slosh tank 4 m x 4 m x 2 m, damping factor 0.05
wetPanelTankFileName cube4mWetPanelSloshTank.bin
sloshTankRadDBFileName cube4mSloshTankRadDB.bin
dampingFactor 0.05 2 8
hydroCompOptions 1.000 20.000 20.000 SourceGauss Galerkin 2
enFreqRange 0.05 10 0.05
begin condLimits
enFreqsLongLimits 0 10
condLimitsLong 99000 99000
enFreqsLatLimits 0 10
condLimitsLat 99000 99000
end condLimits
tRetardIncMax 0.1 50
enFreqIntegrateIncMax 0.05 10
tDelayMaxCorrectionOption TRetardMaxCorrection
outRetardOption NoOutRetard
plotOutOption NoPlots
end SM3DRadSloshTank3
```

D.3 Sample Output File for SM3DRadSloshTank3

Program SM3DRadSloshTank3
ShipMo3D 3.0 Version 3.0 release - 5 October 2011
Time : November-09-11 8:53:27 AM
Run label:
Cube slosh tank 4 m x 4 m x 2 m, damping factor 0.05

**** ECHO OF USER INPUT ****

Input wet panel file name:
cube4mWetPanelSloshTank.bin
Label : Cube slosh tank 4 m x 4 m x 2 m
Created : November-09-11 8:31:31 AM
Version : ShipMo3D 3.0 Version 3.0 release - 5 October 2011
Class : ShipMo3D.Sloshing.WetPanelSloshTankInterior

Sloshing tank radiation database file name:
cube4mSloshTankRadDB.bin
Fluid flow damping factor peak : 0.050
Lower encounter frequency for peak : 2.000
Upper encounter frequency for peak : 8.000

Parameters for computing hydrodynamic coefficients (input)
Green function transition frequency : 1.000 rad/s
R threshold for exact integration : 20.0
R1 threshold for exact integration : 20.0
Source panel Gauss option : SourceGauss
Field panel Galerkin option : Galerkin
Order for Gauss quadrature : 2

Encounter frequency range
Minimum : 0.050 (rad/s)
Maximum : 10.000 (rad/s)
Increment : 0.050 (rad/s)

User input limits on matrix condition numbers
Matrix condition number limits for longitudinal motions
Encounter frequency (rad/s) Condition number limit
0.000 99000.0
10.000 99000.0
Matrix condition number limits for lateral motions
Encounter frequency (rad/s) Condition number limit
0.000 99000.0

10.000

99000.0

Parameters for evaluation of sloshing retardation functions

Time increment : 0.100 s
 Time maximum : 50.000 s
 Encounter frequency increment : 0.050 rad/s
 Encounter frequency maximum time : 10.000 rad/s
 Option for correction for tDelayMax : TRetardMaxCorrection
 Option for output of retardation function tables : NoOutRetard

Plot option : NoPlots

**** COMPUTED HYDRODYNAMIC COEFFICIENTS****

Time for computing coefficients: 485 s

Summary of added mass and damping for a tank containing fluid
 Added masses include effect of static fluid
 Vertical origin located at tank fluid line
 Added mass non-dimensionalised by modal inertia.
 Damping non-dimensionalised by (modal inertia*encounter frequency).

Fluid mass : 32000.000 kg
 Roll gyradius : 1.628 m
 Pitch gyradius : 1.628 m
 Yaw gyradius : 1.628 m

Longitudinal modes

Encounter frequency rad/s	Surge		Pitch		Condition number
	Added mass	Damping	Added mass	Damping	
0.000	0.958	0.000	0.169	0.000	
0.050	0.958	0.000	0.169	0.000	142.6
0.100	0.959	0.000	0.169	0.000	161.0
0.150	0.960	0.000	0.169	0.000	205.9
0.200	0.961	0.000	0.169	0.000	335.2
0.250	0.962	0.001	0.170	0.000	933.2
0.300	0.964	0.001	0.170	0.000	624.6
0.350	0.967	0.001	0.170	0.000	249.6
0.400	0.969	0.002	0.170	0.000	144.0
0.450	0.972	0.002	0.170	0.000	98.3
0.500	0.975	0.003	0.170	0.000	73.6
0.550	0.979	0.004	0.170	0.000	58.5
0.600	0.983	0.005	0.170	0.000	48.4

0.650	0.988	0.005	0.170	0.000	41.3
0.700	0.993	0.006	0.171	0.000	36.1
0.750	0.999	0.007	0.171	0.000	32.2
0.800	1.005	0.009	0.171	0.000	29.2
0.850	1.012	0.010	0.171	0.000	26.9
0.900	1.019	0.011	0.171	0.000	25.1
0.950	1.027	0.013	0.172	0.000	23.8
1.000	1.036	0.015	0.172	0.001	22.7
1.050	1.045	0.017	0.172	0.001	22.0
1.100	1.055	0.019	0.173	0.001	21.3
1.150	1.066	0.021	0.173	0.001	20.8
1.200	1.078	0.024	0.173	0.001	20.4
1.250	1.091	0.027	0.174	0.001	20.1
1.300	1.105	0.030	0.174	0.001	19.9
1.350	1.120	0.033	0.175	0.001	19.7
1.400	1.136	0.037	0.175	0.001	19.6
1.450	1.154	0.041	0.176	0.001	19.5
1.500	1.174	0.046	0.176	0.002	19.4
1.550	1.196	0.051	0.177	0.002	19.4
1.600	1.219	0.057	0.178	0.002	19.4
1.650	1.245	0.064	0.179	0.002	19.4
1.700	1.274	0.071	0.180	0.002	19.5
1.750	1.306	0.080	0.181	0.003	19.5
1.800	1.342	0.090	0.182	0.003	19.7
1.850	1.382	0.101	0.183	0.003	20.1
1.900	1.427	0.114	0.185	0.004	20.6
1.950	1.479	0.130	0.186	0.004	21.2
2.000	1.538	0.149	0.188	0.005	21.9
2.050	1.607	0.164	0.191	0.005	22.9
2.100	1.689	0.184	0.193	0.006	24.0
2.150	1.786	0.208	0.196	0.006	25.4
2.200	1.904	0.240	0.200	0.007	27.2
2.250	2.049	0.282	0.205	0.009	29.5
2.300	2.231	0.341	0.211	0.010	32.6
2.350	2.466	0.425	0.218	0.013	37.2
2.400	2.781	0.553	0.229	0.017	43.7
2.450	3.221	0.766	0.243	0.023	53.0
2.500	3.870	1.160	0.264	0.036	67.6
2.550	4.879	2.018	0.297	0.062	93.6
2.600	6.332	4.376	0.345	0.137	148.0
2.650	4.730	11.254	0.299	0.359	255.4
2.700	-5.956	8.957	-0.046	0.293	237.2
2.750	-5.317	2.937	-0.030	0.099	151.1
2.800	-3.635	1.205	0.023	0.042	104.1
2.850	-2.600	0.608	0.056	0.022	80.8

2.900	-1.948	0.348	0.077	0.014	66.4
2.950	-1.509	0.217	0.091	0.009	57.0
3.000	-1.195	0.143	0.101	0.006	50.5
3.050	-0.960	0.099	0.108	0.005	46.3
3.100	-0.778	0.070	0.114	0.004	43.8
3.150	-0.634	0.051	0.119	0.003	42.0
3.200	-0.516	0.038	0.123	0.003	40.7
3.250	-0.418	0.029	0.126	0.002	39.7
3.300	-0.335	0.023	0.129	0.002	39.0
3.350	-0.265	0.018	0.131	0.002	38.9
3.400	-0.204	0.014	0.133	0.002	39.4
3.450	-0.150	0.012	0.135	0.001	40.2
3.500	-0.103	0.010	0.136	0.001	41.3
3.550	-0.061	0.008	0.138	0.001	43.6
3.600	-0.023	0.007	0.139	0.001	47.0
3.650	0.011	0.006	0.140	0.001	52.3
3.700	0.042	0.006	0.141	0.001	61.1
3.750	0.070	0.005	0.142	0.001	74.0
3.800	0.097	0.005	0.143	0.001	96.4
3.850	0.121	0.005	0.144	0.001	154.1
3.900	0.144	0.005	0.145	0.001	448.5
3.950	0.165	0.005	0.145	0.001	347.4
4.000	0.186	0.005	0.146	0.001	149.7
4.050	0.206	0.005	0.147	0.001	118.7
4.100	0.224	0.005	0.148	0.001	163.1
4.150	0.243	0.005	0.148	0.001	307.0
4.200	0.262	0.005	0.149	0.001	179.1
4.250	0.280	0.006	0.150	0.001	101.5
4.300	0.300	0.007	0.151	0.001	74.1
4.350	0.320	0.007	0.152	0.001	60.3
4.400	0.342	0.008	0.153	0.001	53.3
4.450	0.367	0.010	0.154	0.001	52.8
4.500	0.396	0.012	0.156	0.002	56.4
4.550	0.432	0.016	0.158	0.002	69.2
4.600	0.481	0.023	0.161	0.002	101.2
4.650	0.554	0.036	0.166	0.003	187.7
4.700	0.680	0.071	0.174	0.006	192.0
4.750	0.961	0.211	0.193	0.015	116.1
4.800	1.365	1.655	0.219	0.113	235.9
4.850	-0.662	0.530	0.082	0.036	133.1
4.900	-0.198	0.125	0.114	0.009	72.7
4.950	-0.019	0.057	0.126	0.004	54.9
5.000	0.072	0.034	0.132	0.003	48.1
5.050	0.128	0.024	0.135	0.002	46.4
5.100	0.167	0.018	0.138	0.002	49.4

5.150	0.196	0.015	0.140	0.001	57.0
5.200	0.218	0.013	0.141	0.001	77.9
5.250	0.237	0.011	0.142	0.001	136.2
5.300	0.253	0.011	0.143	0.001	145.5
5.350	0.266	0.010	0.144	0.001	75.9
5.400	0.278	0.009	0.144	0.001	59.8
5.450	0.289	0.009	0.145	0.001	64.3
5.500	0.299	0.009	0.145	0.001	106.3
5.550	0.308	0.008	0.146	0.001	254.1
5.600	0.317	0.008	0.146	0.001	150.9
5.650	0.325	0.008	0.147	0.001	173.4
5.700	0.334	0.008	0.147	0.001	90.7
5.750	0.342	0.008	0.147	0.001	69.8
5.800	0.351	0.008	0.148	0.001	86.9
5.850	0.361	0.008	0.148	0.001	162.1
5.900	0.371	0.009	0.148	0.001	149.1
5.950	0.384	0.010	0.149	0.001	77.8
6.000	0.400	0.012	0.149	0.001	52.9
6.050	0.422	0.016	0.150	0.001	45.3
6.100	0.459	0.027	0.151	0.001	53.2
6.150	0.532	0.074	0.154	0.003	77.5
6.200	0.561	0.380	0.155	0.012	130.3
6.250	0.140	0.205	0.142	0.007	107.2
6.300	0.222	0.064	0.144	0.003	61.7
6.350	0.269	0.034	0.146	0.002	51.4
6.400	0.296	0.023	0.147	0.001	63.9
6.450	0.314	0.018	0.147	0.001	81.3
6.500	0.326	0.016	0.148	0.001	68.3
6.550	0.335	0.014	0.148	0.001	65.4
6.600	0.343	0.013	0.148	0.001	68.3
6.650	0.350	0.012	0.148	0.001	60.0
6.700	0.356	0.011	0.149	0.001	52.0
6.750	0.361	0.011	0.149	0.001	68.4
6.800	0.366	0.010	0.149	0.001	126.2
6.850	0.371	0.010	0.149	0.001	104.2
6.900	0.376	0.009	0.149	0.001	78.4
6.950	0.381	0.009	0.149	0.001	75.5
7.000	0.386	0.009	0.150	0.001	85.1
7.050	0.392	0.009	0.150	0.001	72.8
7.100	0.399	0.009	0.150	0.001	53.6
7.150	0.407	0.010	0.150	0.001	50.6
7.200	0.418	0.012	0.150	0.001	53.6
7.250	0.437	0.019	0.151	0.001	48.2
7.300	0.469	0.051	0.151	0.002	51.7
7.350	0.423	0.166	0.151	0.004	69.5

7.400	0.322	0.084	0.149	0.003	59.6
7.450	0.341	0.038	0.149	0.002	55.5
7.500	0.357	0.025	0.149	0.001	58.0
7.550	0.367	0.020	0.150	0.001	48.4
7.600	0.374	0.017	0.150	0.001	37.0
7.650	0.379	0.015	0.150	0.001	33.3
7.700	0.384	0.013	0.150	0.001	39.4
7.750	0.388	0.012	0.150	0.001	46.6
7.800	0.391	0.012	0.150	0.001	49.9
7.850	0.395	0.011	0.150	0.001	75.2
7.900	0.398	0.010	0.150	0.001	65.8
7.950	0.401	0.010	0.150	0.001	57.3
8.000	0.405	0.010	0.151	0.001	61.4
8.050	0.408	0.009	0.151	0.001	47.2
8.100	0.413	0.009	0.151	0.001	45.1
8.150	0.418	0.009	0.151	0.001	41.7
8.200	0.426	0.010	0.151	0.001	36.3
8.250	0.438	0.017	0.151	0.001	39.5
8.300	0.453	0.044	0.152	0.001	47.5
8.350	0.408	0.079	0.151	0.002	50.1
8.400	0.383	0.044	0.151	0.002	42.5
8.450	0.389	0.027	0.151	0.001	39.0
8.500	0.394	0.020	0.151	0.001	33.9
8.550	0.398	0.017	0.151	0.001	30.8
8.600	0.402	0.014	0.151	0.001	27.9
8.650	0.405	0.012	0.151	0.001	28.9
8.700	0.407	0.011	0.151	0.001	33.9
8.750	0.410	0.010	0.151	0.001	42.7
8.800	0.412	0.009	0.151	0.001	47.2
8.850	0.415	0.008	0.151	0.001	40.2
8.900	0.417	0.008	0.151	0.001	41.4
8.950	0.420	0.007	0.151	0.001	34.0
9.000	0.423	0.007	0.151	0.001	31.0
9.050	0.428	0.007	0.151	0.001	29.5
9.100	0.434	0.008	0.151	0.001	31.9
9.150	0.443	0.014	0.152	0.001	33.4
9.200	0.445	0.036	0.152	0.001	34.2
9.250	0.418	0.042	0.152	0.001	30.9
9.300	0.411	0.028	0.151	0.001	26.6
9.350	0.412	0.020	0.151	0.001	26.5
9.400	0.414	0.016	0.151	0.001	24.3
9.450	0.416	0.013	0.151	0.001	22.7
9.500	0.418	0.011	0.151	0.001	23.6
9.550	0.420	0.010	0.151	0.001	26.0
9.600	0.422	0.009	0.151	0.001	31.3

9.650	0.424	0.008	0.152	0.001	30.9
9.700	0.426	0.007	0.152	0.001	28.9
9.750	0.428	0.006	0.152	0.001	26.9
9.800	0.430	0.005	0.152	0.001	24.3
9.850	0.434	0.005	0.152	0.001	23.3
9.900	0.439	0.005	0.152	0.001	21.9
9.950	0.446	0.009	0.152	0.001	21.2
10.000	0.448	0.024	0.152	0.001	22.1
Infinite	0.477	0.000	0.153	0.000	

Lateral modes

Encounter frequency rad/s	Sway		Roll		Yaw		Condition number
	Added mass	Damping	Added mass	Damping	Added mass	Damping	
0.000	0.963	0.000	0.170	0.000	0.153	0.000	
0.050	0.963	0.000	0.170	0.000	0.153	0.000	4.7
0.100	0.963	0.000	0.170	0.000	0.153	0.000	4.7
0.150	0.964	0.000	0.170	0.000	0.153	0.000	4.7
0.200	0.965	0.000	0.170	0.000	0.153	0.000	4.7
0.250	0.967	0.001	0.170	0.000	0.153	0.000	4.7
0.300	0.969	0.001	0.170	0.000	0.153	0.000	4.7
0.350	0.971	0.001	0.170	0.000	0.153	0.000	4.7
0.400	0.974	0.002	0.170	0.000	0.153	0.000	4.7
0.450	0.977	0.002	0.170	0.000	0.153	0.000	4.7
0.500	0.980	0.003	0.170	0.000	0.153	0.000	4.7
0.550	0.984	0.004	0.170	0.000	0.153	0.000	4.7
0.600	0.988	0.005	0.170	0.000	0.153	0.000	4.8
0.650	0.993	0.005	0.171	0.000	0.153	0.000	4.8
0.700	0.998	0.006	0.171	0.000	0.154	0.000	4.8
0.750	1.003	0.007	0.171	0.000	0.154	0.000	4.8
0.800	1.010	0.009	0.171	0.000	0.154	0.000	4.8
0.850	1.016	0.010	0.171	0.000	0.154	0.000	4.9
0.900	1.024	0.011	0.172	0.000	0.154	0.000	4.9
0.950	1.031	0.013	0.172	0.000	0.154	0.000	4.9
1.000	1.040	0.015	0.172	0.001	0.154	0.000	5.0
1.050	1.050	0.017	0.172	0.001	0.154	0.000	5.0
1.100	1.060	0.019	0.173	0.001	0.154	0.000	5.1
1.150	1.071	0.021	0.173	0.001	0.154	0.000	5.2
1.200	1.083	0.024	0.174	0.001	0.154	0.000	5.3
1.250	1.096	0.027	0.174	0.001	0.154	0.000	5.4
1.300	1.110	0.030	0.174	0.001	0.154	0.000	5.6
1.350	1.125	0.033	0.175	0.001	0.154	0.000	5.8
1.400	1.141	0.037	0.175	0.001	0.155	0.001	5.9
1.450	1.159	0.041	0.176	0.001	0.155	0.001	6.1

1.500	1.179	0.046	0.177	0.002	0.155	0.001	6.4
1.550	1.201	0.051	0.177	0.002	0.155	0.001	6.6
1.600	1.224	0.057	0.178	0.002	0.155	0.001	6.9
1.650	1.250	0.064	0.179	0.002	0.155	0.001	7.2
1.700	1.279	0.071	0.180	0.002	0.155	0.001	7.5
1.750	1.312	0.080	0.181	0.003	0.155	0.001	7.8
1.800	1.347	0.089	0.182	0.003	0.156	0.001	8.2
1.850	1.388	0.100	0.183	0.003	0.156	0.001	8.6
1.900	1.433	0.114	0.185	0.004	0.156	0.001	9.0
1.950	1.485	0.129	0.186	0.004	0.156	0.001	9.6
2.000	1.544	0.148	0.188	0.005	0.156	0.001	10.3
2.050	1.615	0.163	0.191	0.005	0.157	0.001	11.3
2.100	1.697	0.183	0.193	0.006	0.157	0.001	12.3
2.150	1.795	0.207	0.196	0.006	0.157	0.001	13.5
2.200	1.913	0.239	0.200	0.007	0.157	0.001	14.9
2.250	2.059	0.281	0.205	0.008	0.157	0.001	16.6
2.300	2.242	0.339	0.211	0.010	0.158	0.001	18.9
2.350	2.480	0.422	0.218	0.013	0.158	0.001	22.1
2.400	2.798	0.551	0.228	0.016	0.158	0.001	26.7
2.450	3.243	0.763	0.243	0.023	0.158	0.001	33.4
2.500	3.901	1.158	0.264	0.035	0.159	0.001	44.0
2.550	4.930	2.022	0.297	0.061	0.159	0.001	63.2
2.600	6.427	4.422	0.346	0.136	0.159	0.001	102.3
2.650	4.741	11.507	0.298	0.362	0.160	0.001	178.9
2.700	-6.133	8.904	-0.048	0.287	0.160	0.001	166.5
2.750	-5.339	2.885	-0.027	0.096	0.160	0.001	105.2
2.800	-3.638	1.184	0.025	0.041	0.161	0.001	72.2
2.850	-2.600	0.597	0.058	0.022	0.161	0.001	55.4
2.900	-1.948	0.343	0.078	0.013	0.161	0.001	45.9
2.950	-1.508	0.214	0.092	0.009	0.162	0.001	40.4
3.000	-1.194	0.141	0.102	0.006	0.162	0.001	40.7
3.050	-0.959	0.097	0.109	0.005	0.163	0.001	45.4
3.100	-0.778	0.069	0.115	0.004	0.163	0.001	56.4
3.150	-0.633	0.051	0.120	0.003	0.164	0.001	77.7
3.200	-0.515	0.038	0.124	0.003	0.164	0.001	120.9
3.250	-0.417	0.029	0.127	0.002	0.165	0.001	197.3
3.300	-0.334	0.022	0.129	0.002	0.166	0.001	220.1
3.350	-0.263	0.018	0.132	0.002	0.166	0.001	118.4
3.400	-0.202	0.014	0.134	0.002	0.167	0.001	84.6
3.450	-0.149	0.011	0.135	0.002	0.168	0.002	65.9
3.500	-0.101	0.010	0.137	0.001	0.169	0.002	54.5
3.550	-0.059	0.008	0.138	0.001	0.170	0.002	46.7
3.600	-0.021	0.007	0.139	0.001	0.171	0.002	41.6
3.650	0.013	0.006	0.141	0.001	0.172	0.002	39.3
3.700	0.044	0.006	0.142	0.001	0.173	0.002	38.1

3.750	0.072	0.005	0.143	0.001	0.174	0.002	38.2
3.800	0.099	0.005	0.143	0.001	0.175	0.002	39.2
3.850	0.123	0.005	0.144	0.001	0.176	0.002	41.1
3.900	0.146	0.005	0.145	0.001	0.178	0.002	43.7
3.950	0.168	0.005	0.146	0.001	0.180	0.002	47.8
4.000	0.188	0.005	0.147	0.001	0.181	0.002	56.9
4.050	0.208	0.005	0.147	0.001	0.184	0.003	77.0
4.100	0.227	0.005	0.148	0.001	0.186	0.003	132.9
4.150	0.245	0.005	0.149	0.001	0.188	0.003	257.8
4.200	0.264	0.006	0.150	0.001	0.191	0.003	154.1
4.250	0.283	0.006	0.151	0.001	0.194	0.004	87.7
4.300	0.302	0.007	0.151	0.001	0.198	0.004	61.9
4.350	0.323	0.007	0.152	0.001	0.203	0.005	48.8
4.400	0.345	0.008	0.154	0.001	0.208	0.005	41.5
4.450	0.369	0.010	0.155	0.001	0.214	0.006	38.6
4.500	0.399	0.012	0.157	0.002	0.222	0.007	37.5
4.550	0.435	0.015	0.159	0.002	0.231	0.008	37.9
4.600	0.484	0.021	0.162	0.002	0.243	0.010	40.0
4.650	0.557	0.034	0.166	0.003	0.260	0.014	45.5
4.700	0.684	0.065	0.174	0.005	0.282	0.019	55.3
4.750	0.977	0.194	0.193	0.014	0.316	0.028	78.6
4.800	1.545	1.744	0.230	0.118	0.373	0.048	227.0
4.850	-0.705	0.488	0.081	0.032	0.483	0.107	130.2
4.900	-0.199	0.112	0.115	0.008	0.720	0.404	159.2
4.950	-0.017	0.050	0.127	0.004	-0.360	1.022	237.3
5.000	0.075	0.030	0.133	0.002	-0.296	0.170	117.2
5.050	0.131	0.022	0.136	0.002	-0.121	0.055	76.2
5.100	0.170	0.017	0.138	0.002	-0.041	0.026	61.7
5.150	0.199	0.014	0.140	0.001	0.004	0.014	56.7
5.200	0.221	0.012	0.142	0.001	0.032	0.009	67.5
5.250	0.240	0.011	0.143	0.001	0.052	0.006	124.2
5.300	0.256	0.010	0.143	0.001	0.067	0.005	132.5
5.350	0.269	0.010	0.144	0.001	0.078	0.004	65.1
5.400	0.281	0.009	0.145	0.001	0.087	0.003	47.6
5.450	0.292	0.009	0.145	0.001	0.095	0.002	42.8
5.500	0.302	0.009	0.146	0.001	0.101	0.002	44.7
5.550	0.311	0.009	0.146	0.001	0.107	0.002	54.3
5.600	0.320	0.008	0.147	0.001	0.112	0.002	87.6
5.650	0.329	0.008	0.147	0.001	0.117	0.002	134.7
5.700	0.337	0.008	0.147	0.001	0.122	0.002	112.3
5.750	0.345	0.008	0.148	0.001	0.126	0.002	96.7
5.800	0.354	0.009	0.148	0.001	0.131	0.002	56.1
5.850	0.364	0.009	0.149	0.001	0.136	0.003	42.2
5.900	0.374	0.009	0.149	0.001	0.142	0.003	36.3
5.950	0.387	0.010	0.149	0.001	0.148	0.004	33.0

6.000	0.402	0.012	0.150	0.001	0.156	0.006	34.2
6.050	0.425	0.015	0.151	0.001	0.166	0.009	38.9
6.100	0.462	0.025	0.152	0.001	0.181	0.014	50.5
6.150	0.541	0.067	0.154	0.002	0.204	0.026	79.2
6.200	0.613	0.420	0.156	0.012	0.245	0.062	147.3
6.250	0.113	0.191	0.142	0.006	0.268	0.220	135.0
6.300	0.221	0.056	0.145	0.002	-0.031	0.211	134.3
6.350	0.272	0.030	0.147	0.002	-0.001	0.058	74.1
6.400	0.299	0.020	0.147	0.001	0.040	0.024	69.2
6.450	0.317	0.017	0.148	0.001	0.063	0.012	86.5
6.500	0.329	0.015	0.148	0.001	0.077	0.007	65.8
6.550	0.339	0.014	0.149	0.001	0.087	0.005	46.5
6.600	0.346	0.012	0.149	0.001	0.094	0.004	50.0
6.650	0.353	0.012	0.149	0.001	0.100	0.003	68.7
6.700	0.359	0.011	0.149	0.001	0.105	0.003	76.9
6.750	0.365	0.011	0.149	0.001	0.108	0.003	70.6
6.800	0.370	0.010	0.150	0.001	0.111	0.002	59.6
6.850	0.375	0.010	0.150	0.001	0.115	0.002	67.2
6.900	0.380	0.010	0.150	0.001	0.118	0.002	60.5
6.950	0.384	0.010	0.150	0.001	0.121	0.002	50.4
7.000	0.389	0.010	0.150	0.001	0.124	0.002	55.8
7.050	0.395	0.010	0.150	0.001	0.127	0.002	55.7
7.100	0.402	0.010	0.150	0.001	0.131	0.003	46.7
7.150	0.410	0.011	0.151	0.001	0.136	0.004	47.9
7.200	0.422	0.012	0.151	0.001	0.142	0.006	51.6
7.250	0.441	0.019	0.151	0.001	0.151	0.011	49.7
7.300	0.478	0.049	0.152	0.001	0.164	0.023	56.6
7.350	0.427	0.197	0.151	0.004	0.176	0.062	86.8
7.400	0.313	0.077	0.149	0.002	0.104	0.110	84.0
7.450	0.342	0.034	0.150	0.002	0.066	0.047	63.7
7.500	0.360	0.023	0.150	0.001	0.080	0.019	61.3
7.550	0.370	0.019	0.150	0.001	0.091	0.010	51.4
7.600	0.377	0.016	0.150	0.001	0.099	0.006	49.3
7.650	0.382	0.014	0.151	0.001	0.105	0.005	54.2
7.700	0.387	0.013	0.151	0.001	0.108	0.004	52.2
7.750	0.391	0.012	0.151	0.001	0.111	0.003	46.0
7.800	0.395	0.012	0.151	0.001	0.113	0.002	40.6
7.850	0.398	0.011	0.151	0.001	0.116	0.002	47.8
7.900	0.401	0.011	0.151	0.001	0.118	0.002	52.3
7.950	0.405	0.010	0.151	0.001	0.120	0.001	44.5
8.000	0.408	0.010	0.151	0.001	0.122	0.001	36.8
8.050	0.412	0.010	0.151	0.001	0.125	0.002	36.6
8.100	0.416	0.010	0.151	0.001	0.127	0.002	40.0
8.150	0.421	0.010	0.151	0.001	0.130	0.003	38.9
8.200	0.429	0.011	0.152	0.001	0.135	0.005	37.7

8.250	0.442	0.017	0.152	0.001	0.140	0.009	35.4
8.300	0.461	0.046	0.152	0.001	0.147	0.020	47.4
8.350	0.401	0.088	0.151	0.002	0.139	0.046	58.2
8.400	0.381	0.040	0.151	0.001	0.103	0.041	53.7
8.450	0.391	0.024	0.151	0.001	0.099	0.019	42.2
8.500	0.397	0.019	0.151	0.001	0.104	0.010	38.0
8.550	0.402	0.015	0.151	0.001	0.109	0.006	38.6
8.600	0.405	0.013	0.151	0.001	0.112	0.004	37.2
8.650	0.408	0.012	0.151	0.001	0.114	0.003	31.9
8.700	0.411	0.011	0.152	0.001	0.116	0.002	33.0
8.750	0.414	0.010	0.152	0.001	0.118	0.002	34.5
8.800	0.416	0.009	0.152	0.001	0.120	0.001	36.0
8.850	0.419	0.009	0.152	0.001	0.121	0.001	34.9
8.900	0.421	0.008	0.152	0.001	0.123	0.001	30.0
8.950	0.424	0.008	0.152	0.001	0.125	0.001	29.0
9.000	0.427	0.008	0.152	0.001	0.127	0.001	28.8
9.050	0.431	0.008	0.152	0.001	0.129	0.002	27.2
9.100	0.437	0.009	0.152	0.001	0.132	0.003	27.7
9.150	0.447	0.015	0.152	0.001	0.136	0.007	28.4
9.200	0.450	0.043	0.152	0.001	0.138	0.016	37.8
9.250	0.413	0.043	0.152	0.001	0.125	0.028	36.0
9.300	0.411	0.025	0.152	0.001	0.112	0.019	35.2
9.350	0.414	0.018	0.152	0.001	0.113	0.010	31.3
9.400	0.417	0.014	0.152	0.001	0.115	0.006	26.7
9.450	0.419	0.012	0.152	0.001	0.117	0.004	25.2
9.500	0.422	0.010	0.152	0.001	0.118	0.003	25.0
9.550	0.424	0.009	0.152	0.001	0.120	0.002	23.7
9.600	0.426	0.008	0.152	0.001	0.121	0.001	25.5
9.650	0.427	0.008	0.152	0.001	0.122	0.001	26.1
9.700	0.429	0.007	0.152	0.001	0.124	0.001	24.6
9.750	0.431	0.006	0.152	0.001	0.125	0.000	23.3
9.800	0.434	0.006	0.152	0.001	0.126	0.000	21.4
9.850	0.437	0.006	0.152	0.001	0.128	0.001	21.0
9.900	0.442	0.006	0.152	0.001	0.131	0.002	20.9
9.950	0.449	0.010	0.152	0.001	0.134	0.005	22.9
10.000	0.452	0.027	0.153	0.001	0.135	0.011	26.5
Infinite	0.480	0.000	0.154	0.000	0.134	0.000	

No encounter frequencies removed due to high condition numbers

Annex E: Files for Building Ship with SM3DBuildShip3

E.1 Format of Input Ship File for SM3DBuildShip3

Record (1), Beginning Record

“begin SM3DBuildShip3” (1 character string with 2 words)

Record (2), Run Label

“label”, label (2 character strings)

“label” Record tag.

label Label for run. This can include spaces.

Record (3), Beginning of Note

Input Records (3) to (3b) can optionally be used together to give a descriptive note regarding input.

“begin note” (1 character string with 2 words)

Record (3a), Note

Input Records (3) to (3b) can optionally be used together to give a descriptive note regarding input.

noteText (character string)

noteText Text of note. Multiple lines can be entered.

Record (3b), End of Note

Input Records (3) to (3b) can optionally be used together to give a descriptive note regarding input.

“end note” (1 character string with 2 words)

Record (4), Radiation and Diffraction Database File Name

“radDifDBFileName”, radDifDBFileName (2 character strings)

“radDifDBFileName” Record tag.

radDifDBFileName Name of file of radiation and diffraction computations in .NET binary serialization format. This file should be produced by SM3DRadDif3 before running SM3DBuildShip3.

Record (5), Output Ship Database File Name

“shipDBFileName”, shipDBFileName (2 character strings)

“shipDBFileName” Record tag.

shipDBFileName Name of output ship database file in .NET binary serialization format.

Record (6), Dry Panel Hull Option

“dryPanelOption”, dryPanelOption (2 character strings)

“dryPanelOption” Record tag.

dryPanelOption Option for including dry panel hull.

DryPanel - Dry panel hull is included.

NoDryPanel - Dry panel hull is not included.

Note: Option dryPanel must be selected for time domain simulations that include nonlinear hull forces due to incident waves and buoyancy.

Record (6a), Dry Panel Hull File Name

This record is only required if dryPanelOption is set to dryPanel in Record (6)

“dryPanelFileName”, dryPanelFileName (2 character strings)

“dryPanelFileName” Record tag.

dryPanelFileName Name of input file describing hull in .NET binary format.

Record (7), Length Data

“lengthData”, lpp, stationAP (1 character string, 2 floats)

“lengthData” Record tag.

lpp Ship length between perpendiculars (m)

stationAP Station number of the aft perpendicular. This value is typically 20.0

Note: The values in this record must agree with the values used for the radiation and diffraction database file radDifDBFileName. Values are considered to be in agreement when they are within a tolerance of 0.001 m for length, and 0.001 for the station of the aft perpendicular. The output file from SM3DPanelHull3 gives the values of the above parameters.

Record (8), Load Condition

“loadCondition”, waterDensity, draftBlMid, trimBlStern, shipKG (1 character string, 4 floats)

“waterDensity” Record tag.

waterDensity Water density (kg/m^3).

draftBlMid Draft of baseline at midships (m).

trimBlStern Trim of baseline by stern (m).

shipKG Height of centre of gravity above baseline (m). This value should include the influence of fluid mass present in tanks.

Note: The values in this record must agree with the values used for the radiation and diffraction database file radDifDBFileName. Values are considered to be in agreement when they are within a tolerance of $0.001 \text{ kg}/\text{m}^3$ for density, and 0.001 m for draft, trim, and height of CG.

Record (9), Correction to Metacentric Height

“correctionGM”, correctionGM (1 character string, 1 float)

“correctionGM” Record tag.

correctionGM Correction to metacentric height (m). A negative value can be used to model tank free surface effects. U-tube tanks (Records (20) to (23a) and sloshing tanks (Records (24) to (25a)) explicitly described for the ship should not be included in the correction to metacentric height.

Record (10), Mass Gyradii

“gyradii”, rollGyradius, pitchGyradius, yawGyradius (1 character string, 3 floats)

“gyradii” Record tag.

rollGyradius Roll radius of gyration (m).

pitchGyradius Pitch radius of gyration (m).

yawGyradius Yaw radius of gyration (m).

Record (11), Time Increment and Maximum Value for Hull Hydrodynamic Retardation Forces

“tRetardIncMax”, tRetardInc, tRetardMax (1 character string, 2 floats)

“tRetardIncMax” Record tag.

tRetardInc Time increment for hull hydrodynamic retardation forces (s). A value of approximately $0.05\sqrt{L/g}$ is recommended.

tRetardMax Maximum time for hull hydrodynamic retardation forces (s). A value of approximately $5\sqrt{L/g}$ is recommended.

Record (12), Encounter Frequency Increment and Maximum Value for Integration of Hull Hydrodynamic Retardation Functions

“enFreqIntIncMax”, enFreqIntInc, enFreqIntMax (1 character string, 2 floats)

“enFreqIntIncMax” Record tag.

enFreqIntInc Increment of encounter frequency for computation of retardation forces using integration of frequency domain coefficients. A value of approximately $0.4\sqrt{g/L}$ is recommended.

enFreqIntMax Maximum encounter frequency for computation of retardation forces using integration of frequency domain coefficients. This value should typically correspond with the maximum encounter frequency in the radiation and diffraction database of Record (4). A value of approximately $17\sqrt{g/L}$ is recommended.

Record (13), High Frequency Option for Computing Hull Hydrodynamic Retardation Functions

“retardHighFreqApproxOption”, retardHighFreqApproxOption (2 character strings)

“retardHighFreqApproxOption” Record tag.

retardHighFreqApproxOption When evaluating retardation functions, it is assumed that radiation damping at frequencies greater than enFreqIntMax (Record (12)) decay with with an exponential function of ω_e . If this option is being used, then care should be taken to ensure that radiation damping coefficients from SM3DRadDif at frequency EnFreqIntIncMax are accurate.

noRetardHighFreqApproxOption No high frequency approximation is used when computing retardation function.

Record (14), Beginning of Hull Viscous Data

“begin hullViscous”(1 character string with 2 words)

Record (14a), Ship Speeds in m/s for Resistance Coefficients

One of Records (14a), (14b) or (14c) must be given.

“speedsResist”, speedsResist (1 character string, array of floats)

“speedsResist” Record tag.

speedsResist Array of ship speeds (m/s).

Record (14b), Ship Speeds in Knots for Resistance Coefficients

One of Records (14a), (14b) or (14c) must be given.

“speedsKnotsResist”, speedsKnotsResist (1 character string, array of floats)

“speedsKnotsResist” Record tag.

speedsKnotsResist Array of ship speeds (knots).

Record (14c), Ship Froude Numbers for Resistance Coefficients

One of Records (14a), (14b) or (14c) must be given.

“FroudesResist”, FroudesResist (1 character string, array of floats)

“FroudesResist” Record tag.

FroudesResist Array of Froude numbers.

Record (14d), Ship Resistance Option

“resistOption”, resistOption (2 character strings)

“resistOption” Record tag.

resistOption Option for computing ship resistance.

HoltropMennen - Ship resistance is computed using the method of Holtrop and Mennen as described in Holtrop [27]. This method is suitable for conventional monohull vessels, including those having a bulbous bow.

InputResist - Input ship resistance coefficients are read from Record (14g).

Record (14e), Hull Dimensions for Computing Ship Resistance

This record can optionally be included if resistOption is set to HoltropMennen in Record (14d). If the record is omitted, then values will be set to defaults based on the ship wetted geometry.

“hullResistDim”, draftMidResist, beamResist, blockCoResist, waterplaneCoResist, areaTransomResist, areaMidshipsResist (1 character string, 6 floats)

“hullResistDim”	Record tag.
draftMidResist	Hull draft at midships (m). The default is draftBlMid from Record (8).
beamResist	Hull beam (m). The default is twice the maximum panel y value from the radiation and diffraction database file of Record (4).
blockCoResist	Hull block coefficient C_B . The default is based on the wet panelled hull in the radiation and diffraction database file.
waterplaneCoResist	Hull waterplane area coefficient C_W . The default is based on the wet panelled hull in the radiation and diffraction database file.
areaTransomResist	Cross-sectional area of hull transom (m ²).
areaMidshipsResist	Cross-sectional area of hull at midships (m ²).
Note:	This record should be given as input if the draft and trim of the hull differ significantly from the draft and trim of the baseline.

Record (14f), Bulbous Bow Dimensions for Computing Ship Resistance

This record can optionally be included if resistOption is set to HoltropMennen in Record (14d). If the record is omitted, then it is assumed that the ship has no bulbous bow.

“bulbousBowDim”, areaBulbousBow, zBlBulbousBow, zBlKeelBow (1 character string, 3 floats)

“bulbousBowDim” Record tag.

areaBulbousBow Cross-sectional area of the bulbous bow (m²).

zBlBulbousBow Height of the centre of the bulbous bow above the baseline (m).

zBlKeelBow The height of the ship keel above the baseline at the longitudinal location of the bulbous bow (m).

Record (14g), Ship Resistance Coefficients

This Record must only be given if resistOption is set to InputResist in Record (14d).

“resistCos”, resistCos (1 character string, array of floats)

“resistCos” Record tag.

resistCos Ship non-dimensional resistance coefficients. The resistance coefficients are non-dimensionalized by $1/2 \rho A_w U^2$, with U in m/s for the resistance coefficient. The number of input resistance coefficients must correspond with the number of ship speeds in Record (14a), (14b) or (14c).

Record (14h), Hull Eddy and Lateral Drag Coefficients

This record is optional. If this Records is not given, then parameters are set to defaults.

“hullDragCo”, dragCoEddy, dragCoLateral (1 character strings, 2 floats)

“hullDragCo” Record tag.

dragCoEddy Eddy drag coefficient for roll motion (default 1.17).

dragCoLateral Lateral drag coefficient (default 0.0). Note that lateral drag forces are normally included in nonlinear maneuvering force coefficients, and that the lateral drag coefficient should be zero in such cases.

Record (14i), End of Hull Viscous Force Data

“end hullViscous”(1 character string with 2 words)

Record (15), Beginning of Hull Maneuvering Force Data

“begin hullManeuver”(1 character string with 2 words)

Record (15a), Hull Dimensions for Computing Maneuvering Coefficients

This record is optional. If the record is omitted, then values will be set to defaults.

“hullManeuverDim”, draftMidMan, trimSternMan, beamMan, blockCoMan, zWIMan (1 character string, 5 floats)

“hullManeuverDim” Record tag.

draftMidMan Hull draft at midships (m). The default is draftBlMid from Record (8).

trimSternMan Hull trim by stern (m). The default is trimBlStern from Record (8).

beamMan Hull maximum beam (m). The default is twice the maximum panel y value from the radiation and diffraction database file of Record (4).

blockCoMan Hull block coefficient C_B . The default is based on the wet panelled hull in the radiation and diffraction database file.

zWIMan z coordinate of maneuver force relative to the ship waterline. The default is 0.0.

Note: This record should be given as input if the draft and trim of the hull differ significantly from the draft and trim of the baseline.

Record (15b), Hull Maneuvering Coefficient Method

“hullManMethod”, hullManMethod (2 character strings)

“hullManMethod” Record tag.

hullManMethod Method for evaluating hull maneuvering coefficients.

InputManCo - Input hull maneuvering coefficients are given.

Inoue - Hull maneuvering coefficients are computed based on Inoue et al. [21].

Record (15b1), Nondimensional Hull Maneuvering Coefficients

This record is required if hullManMethod is set to inputManCo in Record (15b).

“hullManCo”, Yv, Yr, Nv, Nr, Yvv, Yvr, Yrr, Nvr2, Nrr, Nrv2 (1 character strings, 10 floats)

“hullManCo” Record tag.

Yv Linear sway-sway force coefficient Y'_v .

Yr Linear sway-yaw force coefficient Y'_r .

Nv Linear yaw-sway force coefficient N'_v .

Nr Linear yaw-yaw force coefficient N'_r .

Yvv Nonlinear sway-sway force coefficient $Y'_{v|v|}$.

Yvr Nonlinear sway-sway force coefficient $Y'_{v|r|}$.

Yrr Nonlinear sway-yaw force coefficient $Y'_{r|r|}$.

Nvr2 Nonlinear yaw-sway force coefficient N'_{vr^2} .

Nrr Nonlinear yaw-yaw force coefficient $N'_{r|r|}$.

Nrv2 Nonlinear yaw-yaw force coefficient N'_{rv^2} .

Record (15b2), Options for Input Hull Maneuvering Coefficients Provided in Record (15b1)

This record is optional if hullManMethod is set to inputManCo in Record (15b).

“inputManCoOptions”, inputManCoAxesOption, inputManCoEnFreqOption (3 character strings)

“inputManCoOptions”	Record tag.
inputManCoAxesOption	Option for input axes system for input hull maneuvering coefficients. StabilityAxes - Input maneuvering coefficients are given for stability axes (default). TranslatingEarthAxes - Input maneuvering coefficients are given for translating earth axes.
inputManCoEnFreqOption	Option for encounter frequency for input hull maneuvering coefficients. Zero - Input maneuvering coefficients are for low frequency motions (default). Infinite - Input maneuvering coefficients are for high frequency motions.

Record (15b3), Increments to Nondimensional Hull Maneuvering Coefficients Evaluated Using the Method of Inoue et al.

This record is optional and can be used if hullManMethod is set to Inoue in Record (15b).

“deltaManCos”, deltaYv, deltaYr, deltaNv, deltaNr, deltaYvv, deltaYvr, deltaYrr, deltaNvr2, deltaNrr, deltaNrv2 (1 character strings, 10 floats)

“deltaManCos” Record tag.

deltaYv	Increment to sway-sway maneuvering force coefficient Y'_v .
deltaYr	Increment to sway-yaw maneuvering force coefficient Y'_r .
deltaNv	Increment to yaw-sway maneuvering force coefficient N'_v .
deltaNr	Increment to sway-sway maneuvering force coefficient N'_r .
deltaYvv	Increment to nonlinear sway-sway maneuvering force coefficient $Y'_{v v}$.
deltaYvr	Increment to nonlinear sway-sway maneuvering force coefficient $Y'_{v r}$.
deltaYrr	Increment to nonlinear sway-yaw maneuvering force coefficient $Y'_{r r}$.
deltaNvr2	Increment to nonlinear yaw-sway maneuvering force coefficient N'_{vr^2} .
deltaNrr	Increment to nonlinear yaw-yaw maneuvering force coefficient $N'_{r r}$.
deltaNrv2	Increment to nonlinear yaw-yaw maneuvering force coefficient N'_{rv^2} .
Note:	If this record is omitted, then all of the above values are set to 0.0.

Record (15c), End of Hull Maneuvering Force Data

“end hullManeuver” (1 character string with 2 words)

Record (16), Beginning of Lift Surface Data

“begin liftSurfaces”(1 character string with 2 words)

Record (16a), Beginning of Bilge Keel Data

Records (16a) to (16a14) are optional, and can be repeated for each bilge keel or pair of bilge keels.

“begin bilgeKeel” (1 character string with 2 words)

Record (16a1), Pair Option

This record must follow Record (16a).

“pairOption”, pairOption (1 character string with 2 words)

“pairOption” Record tag.

pairOption Option for input of single bilge keel or pair of bilge keels.

Single - Input given for a single bilge keel.

Pair - Input is used to create a pair of bilge keels. Input dimensions should be provided for the port bilge keel.

Record (16a2), Bilge Keel Label

This record must follow Record (16a1).

“label” label (2 character strings)

“label” Record tag.

label Label for bilge keel. This can include spaces. If pairOption is set to Pair in Record (16a1), then the port and starboard bilge keel labels will be prefixed with “Port ” and “Starboard ” respectively.

Record (16a3), Bilge Keel Key

This record must follow Record (16a2).

“key” key (2 character strings)

“key” Record tag.

key Key for bilge keel. This should consist of a single word with no spaces. If pairOption is set to Pair in Record (16a1), then the port and starboard bilge keel keys will be prefixed with “Port” and “Starboard” respectively. Note that the key cannot be equal to “All”.

Record (16a4), Bilge Keel Stations

This record must follow Record (16a3).

“stations” stations (1 character string, array of floats)

“stations” Record tag.

stations Stations (increasing) for which bilge keel coordinates are given.

Record (16a5), Lateral Coordinates of Bilge Keel at Root

This record must follow Record (16a4).

“yRoots” yRoots (1 character string, array of floats)

“yRoots” Record tag.

yRoots Lateral offsets of bilge keel root. Input values correspond with stations in Record (16a4). If pairOption is set to Pair in Record (16a), then a factor of -1.0 will be applied to the starboard bilge yRoot values.

Record (16a6), Vertical Coordinates of Bilge Keel at Root

This record must follow Record (16a5).

“zBlRoots” zBlRoots (1 character string, array of floats)

“zBlRoots” Record tag.

zBlRoots Vertical coordinate of bilge keel root relative to baseline. Input values correspond with stations in Record (16a4).

Record (16a7), Spans of Bilge Keel at Root

This record must follow Record (16a6).

“spans” spans (1 character string, array of floats)

“spans” Record tag.

spans Bilge keel spans. Input values correspond with stations in Record (16a4).

Record (16a8), Bilge Keel Dihedral Angles

This record must follow Record (16a7).

“dihedralsDeg” dihedralsDeg (1 character string, array of floats)

“dihedralsDeg” Record tag.

dihedralsDeg Bilge keel dihedral angles (0° oriented to port, 90° oriented upward). Port bilge keels typically have dihedral angles of approximately -45° , and starboard bilge keels typically have dihedral angles of approximately -135° . Input values correspond with stations in Record (16a4). If pairOption is set to Pair in Record (16a), then dihedral angles for the starboard side are evaluated as $(180^\circ - \text{dihedralsDeg})$.

Record (16a9), Bilge Keel Inclusion of Added Mass Option

This record is optional.

“addedMassOption” addedMassOption (2 character strings)

“addedMassOption” Record tag.

addedMassOption Option for including bilge keel added mass.

IncludeAddedMass - added mass is included in bilge keel computations (default).

ExcludeAddedMass - added mass is excluded in bilge keel computations. This option is intended to be used only in rare cases when the bilge keel added mass is already modelled elsewhere, such as when the bilge keel is modelled as part of the ship hull.

Record (16a10), Bilge Keel Roll Damping Parameters

This record is optional, and can follow Record (16a8). If the record is not included, then defaults are used.

“bilgeKeelDamp”, dragCoMethod, wakeFraction, rollVelocityRatio (2 character strings, 2 floats)

“bilgeKeelDamp” Record tag.

dragCoMethod Method for determining bilge keel roll drag coefficient.

Ikeda - Ikeda’s method (default).

Constant - Constant (independent of roll amplitude and velocity). The input drag coefficient is given in Record (16a11).

SimplifiedKatoAmplitude - Simplified Kato method, with drag coefficient decreasing as roll amplitude increases.

SimplifiedKatoVelocity - Simplified Kato method, with drag coefficient decreasing as roll velocity increases.

AmplitudeDecay - Drag coefficient decreasing as roll amplitude increases. Input parameters are given in Record (16a12).

VelocityDecay - Drag coefficient decreasing as roll velocity increases. Input parameters are given in Record (16a13).

wakeFraction Influence of local flow effects on reducing velocity due to ship forward speed (default 0.0).

rollVelocityRatio Influence of local flow effects on flow velocity due to ship roll (default 1.0).

Record (16a11), Bilge Keel Drag Coefficient

This record is required if dragCoMethod has been set to Constant in Record (16a10).

“bilgeKeelDragCo”, dragCoRef (1 character string, 1 float)

“bilgeKeelDragCo” Record tag.

dragCoRef Drag coefficient.

Record (16a12), Bilge Keel Damping Amplitude Decay Parameters

This record is required if dragCoMethod has been set to AmplitudeDecay in Record (16a10).

“bilgeKeelAmpDecay”, dragCoRef, rollAmpRefDeg, alphaDecayDragCo (1 character string, 3 floats)

“bilgeKeelAmpDecay” Record tag.

dragCoRef Reference drag coefficient.

rollAmpRefDeg Reference roll amplitude (deg).

alphaDecayDragCo Reference drag decay coefficient. This value should be \geq 0.0.

Record (16a13), Bilge Keel Damping Velocity Decay Parameters

This record is required if dragCoMethod has been set to VelocityDecay in Record (16a10).

“bilgeKeelVelDecay”, dragCoRef, rollVelAmpRefDeg, alphaDecayDragCo (1 character string, 3 floats)

“bilgeKeelVelDecay” Record tag.

dragCoRef Reference drag coefficient.

rollVelAmpRefDeg Reference roll velocity amplitude (deg/s).

alphaDecayDragCo Reference drag decay coefficient. This value should be \geq 0.0.

Record (16a14), End of Bilge Keel Data

This record must be entered at the end of data for a bilge keel.

“end bilgeKeel” (1 character string with 2 words)

Record (16b), Beginning of Static Foil Data

Records (16b) to (16b8) are optional, and can be repeated for each static foil or static foil pair.

“begin foil” (1 character string with 2 words)

Record (16b1), Pair Option

This record must follow Record (16b).

“pairOption”, pairOption (1 character string with 2 words)

“pairOption” Record tag.

pairOption Option for input of single static foil or pair of static foils.

Single - Input given for a single static foil.

Pair - Input is used to create a pair of static foils. Input dimensions should be provided for the port static foil.

Record (16b2), Static Foil Label

This record must follow Record (16b1).

“label” label (2 character strings)

“label” Record tag.

label Label for static foil. This can include spaces. If pairOption is set to Pair in Record (16b1), then the port and starboard static foil labels will be prefixed with “Port ” and “Starboard ” respectively.

Record (16b3), Static Foil Key

This record must follow Record (16b2).

“key” key (2 character strings)

“key” Record tag.

key Key for static foil. This should consist of a single word with no spaces. If pairOption is set to Pair in Record (16b1), then the port and starboard static foil keys will be prefixed with “Port” and “Starboard” respectively. Note that the key cannot be equal to “All”.

Record (16b4), Static Foil Dimensions

This must follow Record (16b3).

“dimen”, station, yRoot, zBlRoot, span, chordRoot, chordTip, dihedralDeg (1 character string, 7 floats)

“dimen”	Record tag.
station	Station of centroid.
yRoot	Lateral offset of root (m, +port).
zBlRoot	Vertical coordinate of root relative to baseline (m, +up).
span	Span (m).
chordRoot	Chord length at root (m).
chordTip	Chord length at tip (m).
dihedralDeg	Dihedral angle (deg).

Record (16b5), Static Foil Inclusion of Added Mass Option

This record is optional. If this record is not included, then a default value is used.

“addedMassOption” addedMassOption (2 character strings)

“addedMassOption”	Record tag.
addedMassOption	Option for including static foil added mass. IncludeAddedMass - added mass is included in static foil computations (default). ExcludeAddedMass - added mass is excluded in static foil computations. This option is intended to be used only in cases when the static foil added mass is already modelled elsewhere, such as when the static foil is modelled as part of the ship hull. For example, a submarine sail could be modelled as part of the panelled ship hull, and it could also be modelled as a static foil of zero added mass to obtain lift forces.

Record (16b6), Static Foil Wake Fraction

This record is optional. If this record is not included, then a default value is used.

“wakeFraction”, wakeFraction (1 character string, 1 float)

“wakeFraction” Record tag.

wakeFraction Influence of local flow effects on reducing flow velocity due to ship forward speed (default 0.0).

Record (16b7), Static Foil Lift and Drag Coefficients

This record is optional. If this record is not included, then default values are used.

“liftDragCo”, liftCoSlope, dragCo (1 character string, 2 floats)

“liftDragCo” Record tag.

liftCoSlope Lift curve slope $\partial C^{lift}/\partial\alpha$ (/rad). If this record is omitted, then a default value is computed based on the foil aspect ratio.

dragCoNormal Drag coefficient for flow normal to the foil face (default 1.17).

Record (16b8), End of Static Foil Data

This record must follow Record (16b4) or (16b7).

“end foil” (1 character string with 2 words)

Record (16c), Beginning of Skeg Data

Records (16c) to (16c14) are optional, and can be repeated for each skeg or skeg pair.

“begin skeg” (1 character string with 2 words)

Record (16c1), Pair Option

This record must follow Record (16c).

“pairOption”, pairOption (1 character string with 2 words)

“pairOption” Record tag.

pairOption Option for input of single skeg or pair of skegs.

Single - Input given for a single skeg.

Pair - Input is used to create a pair of skegs. Input dimensions should be provided for the port skeg.

Record (16c2), Skeg Label

This record must follow Record (16c1).

“label”, label (2 character strings)

“label” Record tag.

label Label for skeg. This can include spaces. If pairOption is set to Pair in Record (16c1), then the port and starboard skeg labels will be prefixed with “Port ” and “Starboard ” respectively.

Record (16c3), Skeg Key

This record must follow Record (16c2).

“key”, key (2 character strings)

“key” Record tag.

key Key for skeg. This should consist of a single word with no spaces. If pairOption is set to pair in Record (16c1), then the port and starboard skeg keys will be prefixed with “Port” and “Starboard” respectively. Note that the key cannot be equal to “All”.

Record (16c4), Skeg Stations

This record must follow Record (16c3).

“stations”, stations (1 character string, array of floats)

“stations” Record tag.

stations Stations (increasing) for which skeg coordinates are given.

Record (16c5), Lateral Coordinates of Skeg at Root

This record must follow Record (16c4).

“yRoots”, yRoots (1 character string, array of floats)

“yRoots” Record tag.

yRoots Lateral offsets of skeg root. Input values correspond with stations in Record (16c4).

Record (16c6), Vertical Coordinates of Skeg at Root

This record must follow Record (16c5).

“zBlRoots”, zBlRoots (1 character string, array of floats)

“zBlRoots” Record tag.

zBlRoots Vertical coordinate of skeg root relative to baseline. Input values correspond with stations in Record (16c4).

Record (16c7), Spans of Skeg at Root

This record must follow Record (16c6).

“spans”, spans (1 character string, array of floats)

“spans” Record tag.

spans Skeg spans. Input values correspond with stations in Record (16c4).

Record (16c8), Skeg Dihedral Angles

This record must follow Record (13e).

“dihedralsDeg”, dihedralsDeg (1 character string, array of floats)

“dihedralsDeg” Record tag.

dihedralsDeg Skeg dihedral angles (0° oriented to port, 90° oriented upward).
Skegs typically have dihedral angles of approximately -90° .
Input values correspond with stations in Record (16c4).

Record (16c9), Skeg Inclusion of Added Mass Option

This record is optional.

“addedMassOption” addedMassOption (2 character strings)

“addedMassOption” Record tag.

addedMassOption Option for including skeg added mass.

IncludeAddedMass - added mass is included in skeg computations (default).

ExcludeAddedMass - added mass is excluded in skeg computations. This option is intended to be used only in cases when the skeg added mass is already modelled elsewhere, such as when the skeg is modelled as part of the ship hull.

Record (16c10), Skeg Roll Damping Parameters

This record is optional, and can follow Record (16c8). If the record is not included, then defaults are used.

“skegDamp”, dragCoMethod, wakeFraction, rollVelocityRatio (2 character strings, 2 floats)

“skegDamp”	Record tag.
dragCoMethod	Method for determining skeg roll drag coefficient. Ikeda - Ikeda’s method (default). Constant - Constant (independent of roll amplitude and velocity). The input drag coefficient is given in Record (16c11). SimplifiedKatoAmplitude - Simplified Kato method, with drag coefficient decreasing as roll amplitude increases. SimplifiedKatoVelocity - Simplified Kato method, with drag coefficient decreasing as roll velocity increases. AmplitudeDecay - Drag coefficient decreasing as roll amplitude increases. Input parameters are given in Record (16c12). VelocityDecay - Drag coefficient decreasing as roll velocity increases. Input parameters are given in Record (16c13).
wakeFraction	Influence of local flow effects on reducing flow velocity due to ship forward speed (default 0.0).
rollVelocityRatio	Influence of local flow effects on flow velocity due to ship roll (default 1.0).

Record (16c11), Skeg Damping Drag Coefficient

This record is required if dragCoMethod has been set to Constant in Record (16c10).

“skegDragCo”, dragCoRef (1 character string, 1 float)

“skegDragCo”	Record tag.
dragCoRef	Drag coefficient.

Record (16c12), Skeg Damping Amplitude Decay Parameters

This record is required if dragCoMethod has been set to AmplitudeDecay in Record (16c10).

“skegAmpDecay”, dragCoRef, rollAmpRefDeg, alphaDecayDragCo (1 character string, 3 floats)

“skegAmpDecay” Record tag.
dragCoRef Reference drag coefficient.
rollAmpRefDeg Reference roll amplitude (deg).
alphaDecayDragCo Reference drag decay coefficient. This value should be \geq 0.0.

Record (16c13), Skeg Damping Velocity Decay Parameters

This record is required if dragCoMethod has been set to VelocityDecay in Record (16c10).

“skegVelDecay”, dragCoRef, rollVelAmpRefDeg, alphaDecayDragCo

“skegVelDecay” Record tag.
dragCoRef Reference drag coefficient.
rollVelAmpRefDeg Reference roll velocity amplitude (deg/s).
alphaDecayDragCo Reference drag decay coefficient. This value should be \geq 0.0.

Record (16c14), End of Skeg Data

This record must be entered at the end of data for a skeg

“end skeg”(1 character string with 2 words)

Record (16d), Beginning of Rudder Data

Records (16d) to (16d12) are optional, and can be repeated for each rudder or rudder pair.

“begin rudder” (1 character string with 2 words)

Record (16d1), Pair Option

This record must follow Record (16d).

“pairOption”, pairOption (1 character string with 2 words)

“pairOption” Record tag.

pairOption Option for input of single rudder or pair of rudders.

Single - Input given for a single rudder.

Pair - Input is used to create a pair of rudders. Input dimensions should be provided for the port rudder.

Record (16d2), Rudder Label

This record must follow Record (16d1).

“label” label (2 character strings)

“label” Record tag.

label Label for rudder. This can include spaces. If pairOption is set to Pair in Record (16d1), then the port and starboard rudder labels will be prefixed with “Port ” and “Starboard ” respectively.

Record (16d3), Rudder Key

This record must follow Record (16d2).

“key” key (2 character strings)

“key” Record tag.

key Key for rudder. This should consist of a single word with no spaces. If pairOption is set to Pair in Record (16d1), then the port and starboard rudder keys will be prefixed with “Port” and “Starboard” respectively. Note that the key cannot be equal to “All”.

Record (16d4), Rudder Dimensions

This record must follow Record (16d3).

“dimen”, station, yRoot, zBlRoot, span, chordRoot, chordTip, dihedralDeg (1 character string, 7 floats)

“dimen”	Record tag.
station	Station of centroid.
yRoot	Lateral offset of root (m, +port).
zBlRoot	Vertical coordinate of root relative to baseline (m, +up).
span	Span (m).
chordRoot	Chord length at root (m).
chordTip	Chord length at tip (m).
dihedralDeg	Dihedral angle (deg).

Record (16d5), Rudder Incident Flow Coefficients

This record is optional. If this record is not included, then default values are used.

“incFlowCo”, wakeFraction, flowStraighteningCo (1 character string, 2 floats)

“incFlowCo”	Record tag.
wakeFraction	Influence of local flow effects on reducing flow velocity due to ship forward speed (default 0.0).
flowStraighteningCo	Coefficient for reducing the incident flow velocity component normal to the rudder due to flow straightening effects. This coefficient typically has a value between 0.0 and 1.0, with a value of 1.0 indicating that the local normal flow velocity isn't influenced by the propeller, hull, or other effects (default 0.6). For a vertical rudder (most common case), the flow straightening coefficient only influences the incident lateral flow velocity.

Record (16d6), Rudder Lift and Drag Coefficients

This record is optional. If this record is not included, then default values are used.

“liftDragCo”, liftCoSlope, liftCoMax, dragCoSlope, dragCoNormal (1 character string, 4 floats)

“liftDragCo”	Record tag.
liftCoSlope	Lift curve slope $\partial C^{lift} / \partial \alpha$ (/rad). If this record is omitted then a default value is computed based on the foil aspect ratio.
liftCoMax	Maximum value for lift coefficient C^{lift} (default 1.2).
dragCoSlope	Drag curve slope $\partial C^{drag} / \partial (\alpha^2)$ (/rad ²). If this record is omitted then a default value is computed based on the foil aspect ratio.
dragCoNormal	Drag coefficient for flow normal to the rudder surface (default 1.17).

Record (16d7), Rudder Autopilot Control Parameters

This record must follow Record (16d4), (16d5), or (16d6).

“autopilotParam”, deflectMaxDeg, velMaxDeg, accMaxDeg, freqResponse, dampResponse, dtMax (1 character string, 6 floats)

“controlParam”	Record tag.
deflectMaxDeg	Maximum rudder deflection angle (deg). This value is typically set to 35°.
velMaxDeg	Maximum rudder deflection velocity (deg/s). If this value is set to 0.0, then the maximum velocity is unlimited.
accMaxDeg	Maximum rudder acceleration (deg/s ²). If this value is set to 0.0, then the maximum acceleration is unlimited.
freqResponse	Undamped response frequency of rudder autopilot.
dampResponse	Damping of rudder autopilot as a fraction of critical damping. This value is typically between 0.5 and 1.0.
dtMax	Maximum time increment for time stepping of rudder motions. If this value is set to 0.0, then the no limit is applied and time stepping is done using the same time increment as for ship motions.

Record (16d8), Rudder Autopilot Displacement Gains

This record must follow Record (16d7).

“dispGains”, surgeGain, swayGain, heaveGain, rollGain, pitchGain, yawGain (1 character string, 6 floats)

“dispGains” Record tag.

surgeGain Surge gain (deg/m). This value should be 0.0.

swayGain Sway gain (deg/m). This value should be 0.0.

heaveGain Heave gain (deg/m). This value is typically 0.0.

rollGain Roll gain (deg/deg). This value is typically 0.0 unless rudder roll stabilization is desired.

pitchGain Pitch gain (deg/deg). This value is typically 0.0.

yawGain Yaw gain (deg/deg). For a typical ship with a downward oriented rudder, this value is typically ≤ 0.0 .

Record (16d9), Rudder Autopilot Velocity Gains

This record is optional and can follow Record (16d8). If this record is not included, then all velocity gains are set to 0.0.

“velGains”, surgeVelGain, swayVelGain, heaveVelGain, rollVelGain, pitchVelGain, yawVelGain (1 character string, 6 floats)

“velGains” Record tag.

surgeVelGain Surge velocity gain (deg/(m/s)). This value should be 0.0.

swayVelGain Sway velocity gain (deg/(m/s)). This value should be 0.0.

heaveVelGain Heave velocity gain (deg/(m/s)). This value is typically 0.0.

rollVelGain Roll velocity gain (deg/(deg/s)). This value is typically 0.0 unless rudder stabilization is desired.

pitchVelGain Pitch velocity gain (deg/(deg/s)). This value is typically 0.0.

yawVelGain Yaw velocity gain (deg/(deg/s)). For a typical ship with a downward oriented rudder, this value is typically ≤ 0.0 .

Record (16d10), Rudder Autopilot Integral Gains

This record is optional and can follow Record (16d8) or (16d9). If this record is not included, then all integral gains are set to 0.0.

“intGains”, surgeIntGain, swayIntGain, heaveIntGain, rollIntGain, pitchIntGain, yawIntGain (1 character string, 6 floats)

“intGains” Record tag.

surgeIntGain Surge integral gain (deg/(m·s)). This value should be 0.0.

swayIntGain Sway integral gain (deg/(m·s)). This value should be 0.0.

heaveIntGain Heave integral gain (deg/(m·s)). This value is typically 0.0.

rollIntGain Roll integral gain (deg/(deg·s)). This value is typically 0.0 unless rudder stabilization is desired.

pitchIntGain Pitch integral gain (deg/(deg·s)). This value is typically 0.0.

yawIntGain Yaw integral gain (deg/(deg·s)). For a typical ship with a downward oriented rudder, this value is typically ≤ 0.0 .

Record (16d11), Rudder Autopilot Integration Time

This record must be included after Record (16d10) if Record (16d10) is included.

“integrationTime”, integrationTime (1 character string, 1 float)

“integrationTime” Record tag.

integrationTime Integration time for rudder autopilot (s).

Record (16d12), End of Rudder Data

This record must follow Record (16d8) or (16d9).

“end rudder”(1 character string with 2 words)

Record (16e), End of Lift Surfaces Data

“end liftSurfaces”(1 character string with 2 words)

Record (17), Beginning of Propeller Data

“begin propellers”(1 character string with 2 words)

Record (17a), Beginning of Fixed Pitch Propeller

This record is optional, and must follow Record (17). Sequences of Records (17a) to (17a9) can be entered to describe an arbitrary number of fixed pitch propellers.

“begin fixedPitchPropeller” (1 character string with 2 words)

Record (17a1), Pair Option

This record must follow Record (17a).

“pairOption”, pairOption (1 character string with 2 words)

“pairOption” Record tag.

pairOption Option for input of single propeller or pair of propellers.

Single - Input given for a single propeller.

Pair - Input is used to create a pair of propellers. Input dimensions should be provided for the port propeller.

Record (17a2), Fixed Pitch Propeller Label

This record must follow Record (17a1).

“label” label (2 character strings)

“label” Record tag.

label Label for fixed pitch propeller. This can include spaces. If pairOption is set to pair in Record (17a1), then the port and starboard propeller labels will be prefixed with “Port ” and “Starboard ” respectively.

Record (17a3), Fixed Pitch Propeller Key

This record must follow Record (17a2).

“key” label (2 character strings)

“key” Record tag.

key Key for fixed pitch propeller. This should consist of a single word, with no spaces. If pairOption is set to Pair in Record (17a1), then the port and starboard propeller keys will be prefixed with “Port” and “Starboard” respectively. Note that the key cannot be equal to “All”.

Record (17a4), Fixed Pitch Propeller Dimensions

This record must follow Record (17a3).

“dimen”, station, y, zBl, diameter (1 character string, 4 floats)

“dimen” Record tag.

station Station.

y Lateral offset of centre (m, +port).

zBl Vertical coordinate of centre relative to baseline (m, +up).

diameter Diameter (m).

Record (17a5), Fixed Pitch Propeller Hydrodynamic Coefficients

This record must follow Record (17a4).

“propCo”, wakeFraction, thrustDeduction, (1 character string, 2 floats)

“propCo” Record tag.

wakeFraction Wake fraction coefficient.

thrustDeduction Thrust deduction coefficient.

Record (17a6), Fixed Pitch Propeller Thrust Coefficient Quadratic Equation Terms

Either this record or Record (17a7) must follow Record (17a5).

“thrustCoQuadratic”, kt0, ktj1, ktj2 (1 character string, 3 floats)

“thrustCoQuadratic” Record tag.

kt0 Thrust coefficient constant term.

ktj1 Thrust coefficient linear term.

ktj2 Thrust coefficient quadratic term.

Note: The thrust coefficient is evaluated by:
$$K_T = kt0 + ktj1 J_{prop} + ktj2 J_{prop}^2$$
where J_{prop} is the propeller advance coefficient.

Record (17a7), Fixed Pitch Propeller Input Thrust Coefficients

Either this record or Record (17a6) must follow Record (17a5).

“thrustCoInput”, j1, kt1, j2, kt2, j3, kt3 (1 character string, 6 floats)

“thrustCoInput” Record tag.

j1	First advance coefficient.
kt1	Thrust coefficient for advance coefficient j1.
j2	Second advance coefficient.
kt2	Thrust coefficient for advance coefficient j2.
j3	Third advance coefficient.
kt3	Thrust coefficient for advance coefficient j3.

Note:

The thrust coefficient is evaluated by:

$$K_T = kt0 + ktj1 J_{prop} + ktj2 J_{prop}^2$$

where J_{prop} is the propeller advance coefficient. The coefficients kt0, ktj1, and ktj2 are evaluated by matching the input values given in this record.

Record (17a8), Fixed Pitch Propeller Response Parameters

This record must follow Record (17a6) or (17a7).

“propControlParam”, rpmMin, rpmMax, freqResponseRpm, dampResponseRpm, rpmVelMax, rpmAccMax, dtMax (1 character string, 7 floats)

“propControlParam”	Record tag.
rpmMin	Minimum rudder RPM.
rpmMax	Maximum rudder RPM.
freqResponseRpm	Undamped response frequency of propeller controller (rad/s).
dampResponseRpm	Damping of propeller controller as a fraction of critical damping.
rpmVelMax	Maximum rate of change of propeller RPM (RPM/s). If this value is set to 0.0, then the maximum rate of change unlimited.
rpmAccMax	Maximum second derivative of RPM with respect to time (RPM/s ²). If this value is set to 0.0, then no limit is applied.
dtMax	Maximum time increment for time stepping of propeller RPM. If this value is set to 0.0, then time stepping is done using the same time increment as for ship motions.

Record (17a9), End of Data for Fixed Pitch Propeller

This record must follow Record (17a8).

“end fixedPitchPropeller”(1 character string with 2 words)

Record (17b), End of Data for Propellers

“end propellers”(1 character string with 2 words)

Record (18), Beginning of Rudder-Propeller Interaction Coefficients

“begin rudderPropCo”(1 character string with 2 words)

Record (18a), Rudder-Propeller Interaction Coefficients

There can be an arbitrary number of Records (18a).

“rudderPropCo”, rudderKey, propellerKey, rudderPropCo (3 character strings, nPropeller floats)

“rudderPropCo” Record tag.

rudderKey Key of rudder influenced by propeller.

propellerKey Key of propeller influencing rudder.

rudderPropCo Rudder-prop interaction coefficient.

Record (18b), End of Rudder-Propeller Interaction Coefficients

“end rudderPropCo” (1 character string with 2 words)

Record (19), Beginning of Azimuthing Propeller Data

“begin aziPropellers” (1 character string with 2 words)

Record (19a), Beginning of Azimuthing Propeller

This record is optional, and must follow Record (19). Sequences of Records (19a) to (19a18) can be entered to describe an arbitrary number of azimuthing propellers.

“begin aziPropeller” (1 character string with 2 words)

Record (19a1), Pair Option

This record must follow Record (19a).

“pairOption”, pairOption (1 character string with 2 words)

“pairOption” Record tag.

pairOption Option for input of single azimuthing propeller or pair of azimuthing propellers.

Single - Input given for a single azimuthing propeller.

Pair - Input is used to create a pair of azimuthing propellers. Input dimensions should be provided for the port azimuthing propeller.

Record (19a2), Azimuthing Propeller Label

This record must follow Record (19a1).

“label”, label (2 character strings)

“label” Record tag.

label Label for azimuthing propeller. This can include spaces. If pairOption is set to Pair in Record (19a1), then the port and starboard azimuthing propeller labels will be prefixed by “Port ” and “Starboard ” respectively.

Record (19a3), Azimuthing Propeller Key

This record must follow Record (19a2).

“key”, key (2 character strings)

“key” Record tag.

key Key for azimuthing propeller. This should consist of a single word (no spaces). If pairOption is set to Pair in Record (19a1), then the port and starboard azimuthing propeller keys will be appended with “Port” and “Starboard” respectively. Note that the key cannot be equal to “All”.

Record (19a4), Azimuthing Propeller Dimensions

This record must follow Record (19a3).

“dimen”, station, yRoot, zBlRoot, span, chordRoot, chordTip, dihedralDeg, xOffset, diameter (1 character string, 9 floats)

“dimen”	Record tag.
station	Station.
yRoot	Lateral offset of root (m, +port).
zBlRoot	Vertical coordinate of root relative to baseline (m, +up).
span	Span (m)
chordRoot	Chord length at root (m)
chordTip	Chord length at tip (m)
dihedralDeg	Dihedral angle (deg).
xOffset	<i>x</i> offset of propeller when azimuth deflection is 0 degrees (m).
diameter	Propeller diameter (m).

Record (19a5), Azimuthing Propeller Incident Flow and Thrust Deduction Coefficients

This record is optional. If this record is not included, then default values are used.

“incFlowCo”, wakeFraction, flowStraighteningCo, thrustDeduction (1 character string, 3 floats)

“incFlowCo”	Record tag.
wakeFraction	Influence of local flow effects on reducing flow velocity due to ship forward speed (default 0.0).
flowStraighteningCo	Coefficient for reducing the incident flow velocity component normal to the azimuthing propeller due to flow straightening effects. This coefficient typically has a value between 0.0 and 1.0, with a value of 1.0 indicating that the local normal flow velocity isn’t influenced by the propeller, hull, or other effects (default 1.0). For a vertical azimuthing propeller (most common case), the flow straightening coefficient only influences the incident lateral flow velocity.
thrustDeduction	Thrust deduction coefficient for thrust along ship longitudinal axis. This coefficient represents the influence of the propeller on the hull pressure field (default 0.0).

Record (19a6), Option for Symmetry of Input Azimuthing Propeller Force Coefficients

This record must follow Record (19a4) or (19a5).

“forceCoSymOption”, forceCoSymOption (2 character strings)

“forceCoSymOption”	Record tag.
forceCoSymOption	Option for specifying whether force coefficients are symmetrical with respect to attack angle. SymForceCo - Input force coefficients are symmetrical with respect to attack angle. NoSymForceCo - Input force coefficients are not symmetrical with respect to attack angle.

Record (19a7), Attack Angles for Azimuthing Propeller Force Coefficients

This record must follow Record (19a6).

“attackAnglesForceCo”, attackAnglesForceCoDeg (1 character string, array of floats)

“attackAnglesForceCo” Record tag.

attackAnglesForceCoDeg Flow attack angles for input propeller force coefficients (degrees). If forceCoSymOption in Record (19a6) is set to SymForceCo, then flow attack angles must begin with zero degrees and can have a maximum value of 180 degrees. If forceCoSymOption in Record (19a6) is set to NoSymForceCo, then flow attack angles should begin with a negative value and can have a maximum value of 180 degrees.

Record (19a8), Advance Coefficients for Azimuthing Propeller Force AziPropellerAttackForceCo

This record must follow Record (19a6).

“advancesForceCo”, advancesForceCo (1 character string, array of floats)

“advancesForceCo” Record tag.

advancesForceCo Advance coefficients for input propeller force coefficients.

Record (19a9), Azimuthing Propeller Thrust Coefficients for Input Angle of Attack

This record must be repeated nAttackAngleForceCo times, where nAttackAngleForceCo is the number of attack angles specified in Record (19a7).

“thrustCosAttack”, attackAngleDeg, thrustCosAttack (1 character string, 1 + nAdvanceForceCo floats)

“thrustCosAttack” Record tag.

attackAngleDeg Angle of attack for input thrust coefficients. This value must correspond to an input angle in Record (19a7)

thrustCosAttack Thrust force coefficients for angle of attack. The thrust coefficients must correspond to the advance coefficients in Record (19a8).

Record (19a10), Azimuthing Propeller Normal Force Coefficients for Input Angle of Attack

This record must be repeated `nAttackAngleForceCo` times, where `nAttackAngleForceCo` is the number of attack angles specified in Record (19a7).

“`normalForceCosAttack`”, `attackAngleDeg`, `normalForceCosAttack` (1 character string, 1 + `nAdvanceForceCo` floats)

“`normalForceCosAttack`” Record tag.

`attackAngleDeg` Angle of attack for input normal force coefficients. This value must correspond to an input angle in Record (19a7)

`normalForceCosAttack` Thrust force coefficients for angle of attack. The thrust coefficients must correspond to the advance coefficients in Record (19a8).

Record (19a11), Advance Coefficient Below Which Incident Flow Angle is Ignored

This record is optional. If it is omitted, then a default value of 0.001 will be used.

“`advanceCoSmall`”, `advanceCoSmall` (1 character string, 1 float)

“`advanceCoSmall`” Record tag.

`advanceCoSmall` Advance coefficient below which incident flow angle is ignored.

Record (19a12), Azimuthing Propeller RPM Controller Parameters

This record must follow Record (19a10) or (19a11).

“rpmControlParam”, rpmMin, rpmMax, rpmSpeedGain, rpmAccGain, rpmFreqResponse, rpmDampResponse, rpmVelMax, rpmAccMax, rpmDtMax (1 character string, 9 floats)

“rpmControlParam”	Record tag.
rpmMin	Minimum propeller RPM.
rpmMax	Maximum propeller RPM.
rpmFreqResponse	Undamped response frequency of propeller controller (rad/s).
rpmDampResponse	Damping of propeller controller as a fraction of critical damping.
rpmVelMax	Maximum rate of change of propeller RPM (RPM/s). If this value is set to 0.0, then the maximum rate of change is unlimited.
rpmAccMax	Maximum second derivative of RPM with respect to time (RPM/s ²). If this value is set to 0.0, then no limit is applied.
rpmDtMax	Maximum time increment for time stepping of propeller RPM. If this value is set to 0.0, then time stepping is done using the same time increment as for ship motions.

Record (19a13), Azimuthing Propeller Deflection Controller Parameters

This record must follow Record (19a12).

“deflectControlParam”, deflectMaxDeg, deflectVelMaxDeg, deflectAccMaxDeg, deflectFreqResponse, deflectDampResponse, deflectDtMax (1 character string, 6 floats)

“deflectControlParam” Record tag.

deflectMaxDeg Maximum deflection angle (deg). This value is typically set to 35°.

deflectVelMaxDeg Maximum deflection velocity (deg/s). If this value is set to 0.0, then the maximum velocity is unlimited.

deflectAccMaxDeg Maximum deflection acceleration (deg/s²). If this value is set to 0.0, then the maximum acceleration is unlimited.

deflectFreqResponse Undamped response frequency of deflection controller.

deflectDampResponse Damping of deflection controller as a fraction of critical damping. This value is typically between 0.5 and 1.0.

deflectDtMax Maximum time increment for time stepping of azimuthing propeller deflections. If this value is set to 0.0, then the no limit is applied and time stepping is done using the same time increment as for ship motions.

Record (19a14), Azimuthing Propeller Deflection Controller Displacement Gains

This record must follow Record (19a13).

“deflectDispGains”, surgeGain, swayGain, heaveGain, rollGain, pitchGain, yawGain (1 character string, 6 floats)

“deflectDispGains” Record tag.

surgeGain	Surge gain (deg/m). This value should be 0.0.
swayGain	Sway gain (deg/m). This value should be 0.0.
heaveGain	Heave gain (deg/m). This value is typically 0.0.
rollGain	Roll gain (deg/deg). This value is typically 0.0 unless roll stabilization is desired.
pitchGain	Pitch gain (deg/deg). This value is typically 0.0.
yawGain	Yaw gain (deg/deg). For a ship using a downward oriented azimuthing propeller for course keeping, this value is typically ≤ 0.0 .

Record (19a15), Azimuthing Propeller Deflection Controller Velocity Gains

This record is optional and can follow Record (19a14). If this record is not included, then all velocity gains are set to 0.0.

“deflectVelGains”, surgeVelGain, swayVelGain, heaveVelGain, rollVelGain, pitchVelGain, yawVelGain (1 character string, 6 floats)

“deflectVelGains” Record tag.

surgeVelGain	Surge velocity gain (deg/(m/s)). This value should be 0.0.
swayVelGain	Sway velocity gain (deg/(m/s)). This value should be 0.0.
heaveVelGain	Heave velocity gain (deg/(m/s)). This value is typically 0.0.
rollVelGain	Roll velocity gain (deg/(deg/s)). This value is typically 0.0 unless stabilization is desired.
pitchVelGain	Pitch velocity gain (deg/(deg/s)). This value is typically 0.0.
yawVelGain	Yaw velocity gain (deg/(deg/s)). For a ship with using a downward oriented azimuthing propeller for course keeping, this value is typically ≤ 0.0 .

Record (19a16), Azimuthing Propeller Deflection Controller Integral Gains

This record is optional and can follow Record (19a14) or (19a15). If this record is not included, then all integral gains are set to 0.0.

“deflectIntGains”, surgeIntGain, swayIntGain, heaveIntGain, rollIntGain, pitchIntGain, yawIntGain (1 character string, 6 floats)

“deflectIntGains” Record tag.

surgeIntGain Surge integral gain (deg/(m·s)). This value should be 0.0.

swayIntGain Sway integral gain (deg/(m·s)). This value should be 0.0.

heaveIntGain Heave integral gain (deg/(m·s)). This value is typically 0.0.

rollIntGain Roll integral gain (deg/(deg·s)). This value is typically 0.0 unless rudder stabilization is desired.

pitchIntGain Pitch integral gain (deg/(deg·s)). This value is typically 0.0.

yawIntGain Yaw integral gain (deg/(deg·s)). For a ship using a downward oriented azimuthing propeller for course keeping, this value is typically ≤ 0.0 .

Record (19a17), Azimuthing Propeller Deflection Controller Integration Time

This record must be included after Record (19a16) if Record (19a16) is included.

“deflectIntegrationTime”, deflectIntegrationTime (1 character string, 1 float)

“deflectIntegrationTime” Record tag.

deflectIntegrationTime Integration time for deflection controller (s).

Record (19a18), End of Data for Azimuthing Propeller

This record must be given at the end of input data for an azimuthing propeller.

“end aziPropeller” (1 character string with 2 words)

Record (19b), End of Data for Azimuthing Propellers

“end aziPropellers” (1 character string with 2 words)

Record (20), Beginning of U-tube Tank Data

“begin uTubeTanks”(1 character string with 2 words)

Record (20a), Beginning of U-tube Tank

This record is optional, and must follow Record (20). Sequences of Records (20a) to (20a) can be entered to described an arbitrary number of U-tube tanks.

“begin uTubeTank”(1 character string with 2 words)

Record (20a1), U-tube Tank Label

This record must follow Record (20a).

“label”, label (2 character strings)

“label” Record tag.

label Label for U-tube tank.

Record (20a2), U-tube Tank Key

This record must follow Record (20a1).

“key”, key (2 character strings)

“key” Record tag.

key Key for U-tube tank. This should consist of a single word (no spaces).
Note that the key cannot be equal to “All”.

Record (20a3), U-tube Tank Dimensions

This record must follow Record (20a2).

“dimen”, station, zBlBottom, length, widthDuct, widthReservoir, heightDuct, heightTotal (1 character string, 7 floats)

“dimen”	Record tag.
station	Station.
zBlBottom	Vertical coordinate of bottom relative to ship baseline (m, +up).
length	Length in ship longitudinal direction (m).
widthDuct	Width of centre duct (m).
widthReservoir	Width of each side reservoir (m).
heightDuct	Height of duct (deg).
heightTotal	Total height from base to top of reservoir (m).

Record (21), U-tube Tank Fluid Properties

This record must follow Record (20a3).

“fluid”, heightFluid, fluidDensity (1 character string, 2 floats)

“fluid”	Record tag.
heightFluid	Mean height of fluid above tank bottom (m). This value should be greater than heightDuct and less than heightTotal.
fluidDensity	Tank fluid density (kg/m ³). The value will be 1000 kg/m ³ for a tank filled with fresh water.

Record (22), U-tube Tank Nondimensional Damping

This record must follow Record (21).

“damping”, dampingND (1 character string, 1 float)

“damping”	Record tag.
dampingND	Nondimensional damping for tank fluid motion. This value can most accurately be determined using physical experiments or computational fluid dynamics. A value of the order of 0.1 is likely suitable.

Record (23), U-tube Tank Maximum Time Increment

This record can optionally follow Record (22).

“dtMax”, dtMax (1 character string, 1 float)

“dtMax” Record tag.

dtMax Maximum time increment for evaluation of tank fluid motion in the time domain (default 0.0 s). If this value is set to zero, then no limit is used (i.e., the time step for tank fluid motion is the same as the time step for ship motion).

Record (234), End of Data for U-tube Tank

This record must be given at the end of input data for an azimuthing propeller.

“end uTubeTank”(1 character string with 2 words)

Record (23a), End of Data for U-tube Tanks

“end uTubeTanks”(1 character string with 2 words)

Record (24), Beginning of Sloshing Tank Data

“begin sloshTanks”(1 character string with 2 words)

Record (24a), Beginning of Sloshing Tank

This record is optional, and must follow Record (24). Sequences of Records (24a) to (24a) can be entered to described an arbitrary number of sloshing tanks.

“begin sloshTank”(1 character string with 2 words)

Record (24a1), Sloshing Tank Label

This record must follow Record (24a).

“label”, label (2 character strings)

“label” Record tag.

label Label for sloshing tank.

Record (24a2), Sloshing Tank Key

This record must follow Record (24a1).

“key”, key (2 character strings)

“key” Record tag.

key Key for sloshing tank. This should consist of a single word (no spaces).
Note that the key cannot be equal to “All”.

Record (24a3), Sloshing Tank Position

This record must follow Record (24a2).

“position”, station, zBlBottom (1 character string, 2 floats)

“position” Record tag.

station Station.

zBlBottom Vertical coordinate of tank bottom relative to ship baseline (m,
+up).

Record (25), Sloshing Tank Radiation Database File Name

“sloshTankRadDBFileName”, sloshTankRadDBFileName (2 character strings)

“sloshTankRadDBFileName” Record tag.

sloshTankRadDBFileName Name of input file with database of sloshing tank
radiation computations in .NET binary
serialization format. This file is produced by
running SM3DRadSloshTank prior to running
SM3DBuildShip.

Record (254), End of Data for Sloshing Tank

This record must be given at the end of input data for a sloshing tank.

“end sloshTank”(1 character string with 2 words)

Record (25a), End of Data for Sloshing Tanks

“end sloshTanks”(1 character string with 2 words)

Record (26), Beginning of Ship Plot Data

This record is optional.

“begin shipPlots” (1 character string with 2 words)

Note: If this record is entered, then it can be followed by an arbitrary number of repetitions of Records (26a) to (26h) giving plot parameters. Record (26i) must follow at the end of plot parameter data.

Record (26a), Ship Plot Image File Name

This record is required if a plot is being specified.

“imageFileName”, imageFileName (2 character strings)

“imageFileName” Record tag.

imageFileName Name of output plot file.

Record (26b), Ship Plot Image Format

This record is optional if a plot is being specified.

“imageFormat”, imageFormat (2 character strings)

“imageFormat” Record tag.

imageFormat Plot image format. Available formats are png (default) and jpg.

Record (26c), Ship Plot Image Size

This record is optional if a plot is being specified.

“imageSize”, widthmm, heightmm (1 character string, 2 floats)

“imageSize” Record tag.

widthmm Plot width (mm). (Default 150 mm)

heightmm Plot height (mm). (Default 100 mm)

Record (26d), Ship Plot Camera Settings

This record is required if a plot is being specified.

“camera”, camPosHorAngleDeg, camPosVertAngleDeg, camViewAngleDeg (1 character string, 3 floats)

“camera” Record tag.

camPosHorAngleDeg Horizontal position (deg) of camera relative to ship (0 deg for front, 90 deg for left).

camPosVertAngleDeg Vertical position (deg) of camera relative to ship (0 deg for horizontal, 90 deg for above).

camViewAngleDeg Camera view angle (deg).

Record (26e), Ship Plot Lighting Settings

This record is optional if a plot is being specified.

“lighting”, ambientLightIntensity, directLightIntensity, directLightHorAngleDeg, directLightVertAngleDeg (1 character string, 3 floats)

“lighting” Record tag.

ambientLightIntensity Ambient light intensity (default 0.5).

directLightIntensity Direct light intensity (default 1.0).

directLightHorAngleDeg Horizontal position (deg) of direct light source relative to ship (0 deg for front, 90 deg for left, default 0 deg).

directLightVertAngleDeg Vertical position (deg) of direct light source relative to ship (0 deg for horizontal, 90 deg for above, default 45 deg).

Record (26f), Ship Plot Options

This record is required if a plot is being specified.

“shipPlotOptions”, colourTable, showStarboardOption, smoothShadeOption (4 character strings)

“shipPlotOptions”	Record tag.
colourTable	Colour table. Available tables are BlueGreenRedScale, RedHullYellowApp, ShipParts, WetWhiteDryGrey, GreyScale, PartialGreyScale, and White.
showStarboardOption	Option for showing starboard portion of hull. ShowStarboard - Both sides of hull are shown. HideStarboard - Only port side of hull is shown.
smoothShadeOption	Option for shading of hull panels. Solid - Each panel has a solid colour based on the centroid location. Smooth - Each panel can have colour variation within the panel.

Record (26g), Stations for Cropping Plot

This record is optional if a plot is being specified.

“cropStations”, stationMinCrop, stationMaxCrop (1 character string, 2 floats)

“cropStations”	Record tag.
stationMinCrop	Minimum station for cropping plot.
stationMaxCrop	Maximum station for cropping plot.
Note:	If this record is omitted for a plot, then there is no cropping of the plot.

Record (26h), Line Thickness

This record is optional if a plot is being specified.

“lineThickness”, lineThickness (1 character string, 1 float)

“lineThickness”	Record tag.
lineThickness	Line thickness of panels (default 1.0).

Record (26i), End of Ship Plot Data

“end shipPlots” (1 character string with 2 words)

Record (27), Beginning of Retardation Function Plot Data

This record is optional.

“begin retardPlots” (1 character string with 2 words)

Note: If this record is entered, then it can be followed by an arbitrary number of repetitions of Records (27a) to (27f) giving plot parameters. Record (27g) must follow at the end of plot parameter data.

Record (27a), Retardation Plot Image File Name

This record is required if a plot is being specified.

“imageFileName”, imageFileName (2 character strings)

“imageFileName” Record tag.

imageFileName Name of output plot file.

Record (27b), Retardation Plot Image Format

This record is optional if a plot is being specified.

“imageFormat”, imageFormat (2 character strings)

“imageFormat” Record tag.

imageFormat Plot image format. Available formats are png (default) and jpg.

Record (27c), Retardation Plot Image Size

This record is optional if a plot is being specified.

“imageSize”, widthmm, heightmm (1 character string, 2 floats)

“imageSize” Record tag.

widthmm Plot width (mm). (Default 150 mm)

heightmm Plot height (mm). (Default 200 mm)

Record (27d), Option for Longitudinal and/or Lateral Modes

This record is optional if a plot is being specified.

“longLatOption”, longLatOption (2 character strings)

“longLatOption” Record tag.

longLatOption Option for plotting modes.

LongLat - Longitudinal and lateral and modes will be shown with longitudinal modes in the left column and lateral modes in the right column (default).

Long - Longitudinal modes will be shown in a single column.

Lat - Lateral modes will be shown in a single column.

Record (27e), Column Options for Longitudinal Modes

This record is optional if a plot is being specified

“longColumns”, surgeColumn, heaveColumn, pitchColumn (4 character strings)

“longLatColumns” Record tag.

Values for each of the following can be one of:

Left

Right

Hide

surgeColumn Column of surge graph.

heaveColumn Column of heave graph.

pitchColumn Column of pitch graph.

Note: The values in this record will override values set based on longLatOption in Record (27d).

Record (27f), Column Options for Lateral Modes

This record is optional if a plot is being specified.

“latColumns”, swayColumn, rollColumn, yawColumn (5 character strings)

“latColumns” Record tag.

Values for each of the following can be one of:

Left

Right

Hide

swayColumn Column of sway graph.

rollColumn Column of roll graph.

yawColumn Column of yaw graph.

Note: The values in this record will override values set based on longLatOption in Record (27d).

Record (27g), End of Retardation Function Plot Data

“end retardPlots” (1 character string with 2 words)

Record (28), Evaluation of Propeller RPM for Ship Speed Option

“rpmSpeedOption”, rpmSpeedOption (2 character strings)

“rpmSpeedOption” Record tag.

rpmSpeedOption Option for computing propeller RPM for specified ship speeds.

rpmSpeed - Required propeller RPMs are evaluated for specified ship speeds.

noRpmSpeed - Propeller RPMs are not evaluated for ship speeds.

Record (28a), Parameters for Computing Ship RPM Given Speed

This record is required if rpmSpeedOption is set to rpmSpeed in Record (28).

“paramRpmSpeed”, nPropKey, rpmMax, dtMaxRpm, tEndRpm (1 character string, 3 floats)

“paramRpmSpeed”	Record tag.
nPropKey	Number of propeller keys given in Record (28b).
rpmMax	Maximum propeller RPM.
dtMaxRpm	Time step size (s) for simulation of motions. A value of 0.2 s is recommended for full-scale ships.
tEndRpm	End time for simulation of motions to determine final ship speed. A value of 300 s is recommended for full-scale ships.

Record (28b), Propeller Keys for Computing Ship RPM Given Speed

This record is required if rpmSpeedOption is set to rpmSpeed in Record (28).

“keysPropRpm”, keysPropRpm (1 character string, nPropKey integers)

“keysPropRpm”	Record tag.
keysPropRpm	Keys of propellers that are rotating when determining ship speed. If all propellers are running, then nPropKey in Record (28a) can be set to 1 and the propeller key can be set to a value of “All”.

Record (29a), Ship Speeds in m/s for Determining RPM

One of Records (29a), (29b), or (29c) is required if rpmSpeedOption is set to rpmSpeed in Record (28).

“speedsRpm”, speedsRpm (1 character string, array of floats)

“speedsRpm”	Record tag.
speedsRpm	Array of ship speeds (m/s) at which propeller RPM values are determined.

Record (29b), Ship Speeds in Knots for Determining RPM

One of Records (29a), (29b), or (29c) is required if rpmSpeedOption is set to rpmSpeed in Record (28)

“speedsKnotsRpm”, speedsKnotsRpm (1 character string, array of floats)

“speedsKnotsRpm” Record tag.

speedsKnotsRpm Array of ship speeds (knots) at which propeller RPM values are determined.

Record (29c), Froude Numbers for Determining RPM

One of Records (29a), (29b), or (29c) is required if rpmSpeedOption is set to rpmSpeed in Record (28).

“FroudesRpm”, FroudesRpm (1 character string, array of floats)

“FroudesRpm” Record tag.

FroudesRpm Array of Froude numbers at which propeller RPM values are determined.

Record (30), Evaluation of Azimuthing Propeller RPM for Ship Speed Option

“aziRpmSpeedOption”, aziRpmSpeedOption (2 character strings)

“aziRpmSpeedOption” Record tag.

aziRpmSpeedOption Option for computing azimuthing propeller RPM for specified ship speeds.

aziRpmSpeed - Required azimuthing propeller RPMs are evaluated for specified ship speeds.

noAziRpmSpeed - Azimuthing propeller RPMs are not evaluated for ship speeds.

Record (30a), Parameters for Computing Ship Azimuthing Propeller RPM Given Speed

This record is required if aziRpmSpeedOption is set to aziRpmSpeed in Record (30).

“paramAziRpmSpeed”, nAziPropKey, rpmAziMax, dtMaxAziRpm, tEndAziRpm (1 character string, 1 integer, 3 floats)

“paramAziRpmSpeed” Record tag.

nAziPropKey Number of azimuthing propeller keys given in Record (30b).

rpmAziMax Maximum propeller RPM.

dtMaxAziRpm Time step size (s) for simulation of motions. A value of 0.2 s is recommended for full-scale ships.

tEndAziRpm End time for simulation of motions to determine final ship speed. A value of 300 s is recommended for full-scale ships.

Record (30b), Azimuthing Propeller Keys for Computing Ship RPM Given Speed

This record is required if aziRpmSpeedOption is set to aziRpmSpeed in Record (30).

“keysAziPropRpm”, keysAziPropRpm (1 character string, nAziPropKey integers)

“keysAziPropRpm” Record tag.

keysAziPropRpm Keys of azimuthing propellers that are rotating when determining ship speed. If all propellers are running, then nAziPropKey in Record (30a) can be set to 1 and the azimuthing propeller key can be set to a value of “All”.

Record (31a), Ship Speeds in m/s for Determining Azimuthing Propeller RPM

This record or Record (31b) is required if aziRpmSpeedOption is set to aziRpmSpeed in Record (30).

“speedsAziRpm”, speedsAziRpm (1 character string, array of floats)

“speedsAziRpm” Record tag.

speedsAziRpm Array of ship speeds (m/s) at which azimuthing propeller RPM values are determined.

Record (31b), Ship Speeds in Knots for Determining RPM

This record or Record (31a) is required if aziRpmSpeedOption is set to aziRpmSpeed in Record (30)

“speedsKnotsAziRpm”, speedsKnotsAziRpm (1 character string, array of floats)

“speedsKnotsAziRpm” Record tag.

speedsKnotsAziRpm Array of ship speeds (knots) at which azimuthing propeller RPM values are determined.

Record (32), Option and Angle for Evaluation of Azimuthing Propeller Force Slopes

This record is required if aziRpmSpeedOption is set to aziRpmSpeed in Record (30).

“aziForceSlopeOption”, aziForceSlopeOption, aziAttackAngleDeg (2 character strings, 1 float)

“aziForceSlopeOption” Record tag.

aziForceSlopeOption Option for computing azimuthing propeller force slopes $\partial F^{side}/\partial\delta$ and $\partial F^N/\partial\alpha$ which can be used for frequency domain computations.

AziForceSlope - Azimuthing propeller force slopes are evaluated.

NoAziForceSlope - Azimuthing propeller are not evaluated.

aziAttackAngleDeg Flow angle of attack for computing azimuthing propeller force slopes.

Record (33), End of SM3DBuildShip3 Data

“end SM3DBuildShip3”(1 character string with 2 words)

E.2 Sample Input File for SM3DBuildShip3

```
begin SM3DBuildShip3
label Generic frigate
radDifDBFileName genFrigRadDifDB.bin
shipDBFileName genFrigShipForMotionDB.bin
dryPanelOption DryPanel
dryPanelFileName genFrigDryPanelHull.bin
lengthData 120.000 20.000
loadCondition 1025.000 4.200 0.000 6.000
correctionGM 0.000
gyradii 4.800 30.000 30.000
tRetardIncMax 0.100 20.000
enFreqIntIncMax 0.100 5.000
retardHighFreqApproxOption RetardHighFreqApprox
begin hullViscous
    speedsKnotsResist 5 10 15 20 25 30 35
    resistOption HoltropMennen
    hullDragCo 1.17 0
end hullViscous
begin hullManeuver
    hullManMethod Inoue
end hullManeuver
begin liftSurfaces
begin bilgeKeel
    pairOption pair
    label Bilge keel
    key BilgeKeel
    stations 6 7 8 9 10 11 12 13 14
    yRoots 5.14 5.557 5.8 5.83 5.97 5.91 5.8 5.58 5.23
    zBlRoots 2.49 2.21 1.94 1.66 1.66 1.66 1.66 1.66 1.66 1.66
    spans 0.6 0.6 0.6 0.6 0.6 0.6 0.6 0.6 0.6
    dihedralsDeg -45 -45 -45 -45 -45 -45 -45 -45 -45
    addedMassOption includeAddedMass
    bilgeKeelDamp Ikeda 0.000 1.000
end bilgeKeel
begin foil
    pairOption pair
    label Outer shaft bracket
    key OuterBracket
    dimen 18 4 3.04 3 1 1 -105
    addedMassOption includeAddedMass
```



```

    wakeFraction 0.000
end foil
begin foil
    pairOption pair
    label Inner shaft bracket
    key InnerBracket
    dimen 18 0.5 2.5 3.2 1 1 -45
    addedMassOption includeAddedMass
    wakeFraction 0.000
end foil
begin skeg
    pairOption single
    label Skeg
    key Skeg
    stations 14 16
    yRoots 0 0
    zBlRoots 0 0.276
    spans 0 1.2
    dihedralsDeg -90 -90
    addedMassOption includeAddedMass
    skegDamp Ikeda 0.000 1.000
end skeg
begin rudder
    pairOption single
    label Rudder
    key Rudder
    dimen 19 0 3.6 4.8 4.8 2.4 -90
    incFlowCo 0.000 0.600
    autopilotParam 35 3 0 3 0.85 0.1
    dispGains 0 0 0 0 0 -4
    velGains 0 0 0 0 0 -8
end rudder
end liftSurfaces
begin propellers
begin fixedPitchPropeller
    pairOption pair
    label Propeller
    key Propeller
    dimen 18.5 2.9 0.2 4
    propCo 0.000 0.000
    thrustCoQuadratic 0.4 -0.2 -0.16
    propControlParam -300 300 3 0.8 50 0 0.1

```

```
end fixedPitchPropeller
end propellers
begin rudderPropCo
    rudderPropCo Rudder PortPropeller 0.5
    rudderPropCo Rudder StarboardPropeller 0.5
end rudderPropCo
begin aziPropellers
end aziPropellers
begin uTubeTanks
end uTubeTanks
begin sloshTanks
end sloshTanks
plotOutOption NoPlots
rpmSpeedOption rpmSpeed
paramRpmSpeed 1 300 0.2 300
keysPropRpm All
speedsKnotsRpm 5 10 15 20 25 30
aziRpmSpeedOption noAziRpmSpeed
end SM3DBuildShip3
```

E.3 Sample Output File for SM3DBuildShip3

Program SM3DBuildShip3
ShipMo3D 3.0 Version 3.0 release - 5 October 2011
Time : November-09-11 8:19:54 AM

Run label:
Generic frigate

**** ECHO OF USER INPUT ****

Input radiation and diffraction database file name:

genFrigRadDifDB.bin

Label : Generic frigate

Created : November-08-11 4:41:41 PM

Version : ShipMo3D 3.0 Version 3.0 release - 5 October 2011

Class : ShipMo3D.RadDif.HullRadDifDB

Output ship database file name:

genFrigShipForMotionDB.bin

Dry panel hull option : DryPanel

Input hull dry panel file name:

genFrigDryPanelHull.bin

Label : Generic frigate

Created : November-08-11 4:40:16 PM

Version : ShipMo3D 3.0 Version 3.0 release - 5 October 2011

Class : ShipMo3D.HullGeom.DryPanelHull

Ship Length Data

Length between perpendiculars : 120.000 m

Station of aft perpendicular : 20.000

Loading condition

Water density : 1025.000 kg/m3

Draft of baseline at midships : 4.200 m

Trim of baseline by stern : 0.000 m

Height of CG above baseline, KG : 6.000 m

Correction to metacentric height : 0.000 m

Ship gyradii

Roll gyradius : 4.800 m

Pitch gyradius : 30.000 m

Yaw gyradius : 30.000 m

Time parameters for hull retardation forces

Time interval : 0.100 s
Maximum time : 20.000 s

Encounter frequency terms for integration of hull retardation functions

Encounter frequency increment : 0.100 rad/s
Maximum encounter frequency : 5.000 rad/s
High frequency approx option : RetardHighFreqApprox

** Viscous hull input

Ship speeds for resistance (knots)

5.000 10.000 15.000 20.000 25.000 30.000 35.000

Ship resistance option:

Resistance coefficients based on Holtrop and Mennen

Hull geometry for resistance calculations based on wet panel hull

No bulbous bow

User input hull lateral and roll eddy drag coefficients

Eddy-making roll damping coefficient : 1.170
Lateral drag coefficient : 0.000

** Hull maneuvering coefficient input

Hull dimensions for evaluating maneuvering coefficients

Dimensions based on wet panelled hull

Draft at midships : 4.200 m
Trim by stern : 0.000 m
Maximum beam : 14.111 m
Block coefficient : 0.509
Maneuvering force elevation wrt waterline : 0.000 m

Hull maneuvering coefficients based on Inoue regression method

Hull maneuvering coefficients

Sway-sway yv : -0.193807
Sway-yaw yr : 0.054978
Yaw-sway nv : -0.070000
Yaw-yaw nr : -0.032900
Nonlinear sway-sway yvv : -0.859271
Nonlinear sway-sway yvr : -0.180046
Nonlinear sway-yaw yrr : 0.000000
Nonlinear yaw-sway nvr2 : 0.000000
Nonlinear yaw-yaw nrr : -0.060000
Nonlinear yaw-yaw nrv2 : -0.200000

** Lift surfaces input

Input for bilge keel pair, dimensions given for port bilge keel

Label : Bilge keel

Key : BilgeKeel

Station	yRoot (m)	zBlRoot (m)	span (m)	dihedral angle (deg)
6.000	5.140	2.490	0.600	-45.000
7.000	5.557	2.210	0.600	-45.000
8.000	5.800	1.940	0.600	-45.000
9.000	5.830	1.660	0.600	-45.000
10.000	5.970	1.660	0.600	-45.000
11.000	5.910	1.660	0.600	-45.000
12.000	5.800	1.660	0.600	-45.000
13.000	5.580	1.660	0.600	-45.000
14.000	5.230	1.660	0.600	-45.000

Added mass option : IncludeAddedMass (input)

Drag coefficient method : Ikeda (input)

Wake fraction : 0.000 (input)

Roll velocity ratio : 1.000 (input)

Input for static foil pair, dimensions given for port foil

Label : Outer shaft bracket

Key : OuterBracket

Station : 18.000
Y of root : 4.000 m
Z root above baseline : 3.040 m
Span : 3.000 m
Chord at root : 1.000 m
Chord at tip : 1.000 m
Dihedral angle : -105.000 deg

Hydrodynamic parameters

Added mass option : IncludeAddedMass (input)

Wake fraction : 0.000 (input)

Lift coefficient slope : 4.176 /rad (default)

Drag coefficient for normal flow : 1.170 (default)

Input for static foil pair, dimensions given for port foil

Label : Inner shaft bracket

Key : InnerBracket

Station : 18.000
Y of root : 0.500 m
Z root above baseline : 2.500 m
Span : 3.200 m

Chord at root : 1.000 m
 Chord at tip : 1.000 m
 Dihedral angle : -45.000 deg
 Hydrodynamic parameters
 Added mass option : IncludeAddedMass (input)
 Wake fraction : 0.000 (input)
 Lift coefficient slope : 4.255 /rad (default)
 Drag coefficient for normal flow : 1.170 (default)

Input for skeg

Label : Skeg

Key : Skeg

Station	yRoot (m)	zBlRoot (m)	span (m)	dihedral angle (deg)
14.000	0.000	0.000	0.000	-90.000
16.000	0.000	0.276	1.200	-90.000

Added mass option : IncludeAddedMass (input)
 Drag coefficient method : Ikeda (default)
 Wake fraction : 0.000 (default)
 Roll velocity ratio : 1.000 (default)

Input for rudder

Label : Rudder

Key : Rudder

Station : 19.000
 Y of root : 0.000 m
 Z root above baseline : 3.600 m
 Span : 4.800 m
 Chord at root : 4.800 m
 Chord at tip : 2.400 m
 Dihedral angle : -90.000 deg

Hydrodynamic parameters (input)

Wake fraction : 0.000
 Flow straightening coefficient : 0.600
 Lift coefficient slope : 2.938 /rad
 Maximum lift coefficient : 1.200
 Drag coefficient slope : 1.030 /rad**2
 Drag coefficient for normal flow : 1.170

Autopilot parameters

Maximum deflection : 35.000 deg
 Maximum deflection velocity : 3.000 deg/s
 Maximum deflection acceleration : 0.000 deg/s
 Response frequency : 3.000 rad/s
 Response damping : 0.850 (fraction of critical)
 Maximum time step : 0.100000 s

Autopilot displacement gains
 Surge : 0.000 deg/m
 Sway : 0.000 deg/m
 Heave : 0.000 deg/m
 Roll : 0.000 deg/deg
 Pitch : 0.000 deg/deg
 Yaw : -4.000 deg/deg
 Autopilot velocity gains (input)
 Surge : 0.000 deg/(m/s)
 Sway : 0.000 deg/(m/s)
 Heave : 0.000 deg/(m/s)
 Roll : 0.000 deg/(deg/s)
 Pitch : 0.000 deg/(deg/s)
 Yaw : -8.000 deg/(deg/s)
 Autopilot integral gains
 Surge : 0.000 deg/(m*s)
 Sway : 0.000 deg/(m*s)
 Heave : 0.000 deg/(m*s)
 Roll : 0.000 deg/(deg*s)
 Pitch : 0.000 deg/(deg*s)
 Yaw : 0.000 deg/(deg*s)
 Autopilot integration time : 0.000 s (default)

End of lift surface input

Rudder keys and labels

Key	Label
Rudder	: Rudder

** Propeller input

Input for fixed pitch propeller pair, dimensions given for port propeller

Label : Propeller

Key : Propeller

Propeller dimensions

Station	:	18.500
Y of centre	:	2.900 m
Z of centre above baseline	:	0.200 m
Diameter	:	4.000 m

Hydrodynamic characteristics

Wake fraction	:	0.000
Thrust deduction coefficient	:	0.000

Input thrust quadratic coefficients given as input

Thrust coefficient kt0	:	0.400
Thrust coefficient ktj1	:	-0.200

Thrust coefficient ktj2 : -0.160
 Thrust coefficient $K_t = k_{t0} + k_{tj1} * J_{advance} + k_{tj2} * J_{advance}^2$
 Propeller controller parameters
 Minimum RPM : -300.000 deg
 Maximum RPM : 300.000 deg
 Response frequency : 3.000 rad/s
 Response damping : 0.800 (fraction of critical)
 Maximum dRPM/dt : 50.000 RPM/s
 Maximum d2RPM/dt2 : 0.000 RPM/s**2
 Maximum time step : 0.100000 s

End of propeller input

Propeller keys and labels

Key	Label
PortPropeller	: Port Propeller
StarboardPropeller	: Starboard Propeller

** Rudder-propeller interaction coefficients

Rudder key	Propeller key	Interaction coefficient
Rudder	PortPropeller	0.500
Rudder	StarboardPropeller	0.500

** Azimuthing propeller input

End of azimuthing propeller input

** U-tube tank input

End of U-tube tank input

** Sloshing tank input

End of sloshing tank input

Plot output option : NoPlots

Option for computing RPMs from specified speeds : RpmSpeed
 Number of propeller keys for determining RPM : 1
 Maximum allowable RPM : 300.000
 Time step for simulating ship speed : 0.200
 End time for simulating ship speed : 300.000
 Keys of propellers for determining RPM : All
 Ship speeds for computing RPM, (knots)

5.000 10.000 15.000 20.000 25.000 30.000

Option for azimuthing propeller RPMs from specified speeds : NoAziRpmSpeed

**** HULL RADIATION AND DIFFRACTION DATABASE PROPERTIES ****

Summary of data for hull radiation and diffraction computations

Label : Generic frigate

Water density : 1025.000 kg/m3

Encounter frequencies (rad/s)

0.100	0.200	0.300	0.400	0.500	0.600	0.700	0.800
0.900	1.000	1.100	1.200	1.300	1.400	1.500	1.600
1.700	1.800	1.900	2.000	2.400	2.500	2.600	2.700
2.800	2.900	3.000	3.100	3.200	3.300	3.400	3.500
3.600	3.700	4.000	4.400	4.700	4.800	4.900	5.000
5.100	5.200	5.300	5.400	5.500	5.600	5.700	5.800
5.900	6.000						

Ship speeds (m/s)

0.000	2.575	5.150	7.725	10.300	12.875	15.450	18.025
20.600							

Relative sea headings (deg)

0.000	15.000	30.000	45.000	60.000	75.000	90.000	105.000
120.000	135.000	150.000	165.000	180.000			

Relative wave frequencies (rad/s)

0.100	0.200	0.300	0.400	0.500	0.600	0.700	0.800
0.900	1.000	1.100	1.200	1.300	1.400	1.500	1.600
1.700	1.800	1.900	2.000				

**** SHIP RESISTANCE BASED ON HOLTROP, 1984 ****

Ship resistance non-dimensionalized by $0.5 \cdot \rho \cdot A_w \cdot U^{**2}$

ρ = water density 1025.000 kg/m3

A_w = hull wetted surface area 1753.438 m2

U = ship forward speed (m/s)

Speed (m/s)	Speed (knots)	Froude number	Resistance (N)	Non-dimen resistance
2.575	5.000	0.075	20047.803	0.003365
5.150	10.000	0.150	73224.432	0.003072
7.725	15.000	0.225	171874.978	0.003205
10.300	20.000	0.300	356068.721	0.003735

12.875	25.000	0.375	644163.112	0.004324
15.450	30.000	0.450	1080868.484	0.005039
18.025	35.000	0.525	1871341.377	0.006409

***** OUTPUT OF BUILT SHIP PROPERTIES *****

Load Condition Properties for Trimmed Ship

Summary of hydrostatic properties

Number of panels on port side	:	613
Total number of panels	:	1226
Length between perpendiculars	:	120.000 m
Draft of baseline at midships	:	4.200 m
Trim of baseline by stern	:	0.000 m
Beam based on maximum y value	:	14.111 m
Volume	:	3622.358 m3
Water density	:	1025.000 kg/m3
Mass	:	3712916.723463 kg
Distance from FP to X origin (m) (Origin located at LCG)	:	61.750 m
Station of X origin	:	10.292
Center of buoyancy wrt waterline	:	-1.614 m
Wetted surface area	:	1753.438 m2
Waterplane area	:	1344.310 m2
X value of center of floatation	:	-5.022 m
Integral of waterplane area*X**2	:	1234204.219 m4
Integral of waterplane area*Y**2	:	17543.814 m4
KG, height of CG above baseline	:	6.000 m
Height of CG above waterline	:	1.800 m
Metacentric height from hydrostatics	:	1.430 m

Inertial Properties

Inertia matrix, units of kg, kg*m, and kg*m2

3712917	0	0	0	0	0
0	3712917	0	0	0	0
0	0	3712917	0	0	0
0	0	0	85545601	0	0
0	0	0	0	3341625051	0
0	0	0	0	0	3341625051

Roll radius of gyration	:	4.800 m
Pitch radius of gyration	:	30.000 m
Yaw radius of gyration	:	30.000 m

Roll Metacentric Height Properties

Correction to roll metacentric height : 0.000 m
Corrected metacentric height : 1.430 m

Roll Properties at Zero Forward Speed

Roll added mass : 19548240.530169 kg*m**2
Nondimensional roll added mass A44/I44 : 0.229
Natural roll frequency : 0.704 rad/s
Natural roll period : 8.928 s

**** PROPELLER RPM FOR SPECIFIED SHIP SPEEDS ****

Propeller keys : All

Speed (m/s)	Speed (knots)	Froude	RPM	Resistance (N)
2.575	5.000	0.075	41.809	20047.803
5.150	10.000	0.150	82.682	73224.432
7.725	15.000	0.225	124.664	171874.978
10.300	20.000	0.300	169.569	356068.721
12.875	25.000	0.375	216.498	644163.112
15.450	30.000	0.450	266.207	1080868.484
16.965	32.942	0.495	300.000	1511776.640

Computation time : 13 s

This page intentionally left blank.

DOCUMENT CONTROL DATA

(Security classification of title, abstract and indexing annotation must be entered when document is classified)

1. ORIGINATOR (the name and address of the organization preparing the document). Defence R&D Canada - Atlantic		2. SECURITY CLASSIFICATION (overall security classification of the document including special warning terms if applicable) UNCLASSIFIED	
3. TITLE (The complete document title as indicated on the title page. Its classification should be indicated by the appropriate abbreviation (S,C,R or U) in parentheses after the title.) ShipMo3D Version 3.0 User Manual for Creating Ship Models			
4. AUTHORS (Last name, first name, middle initial. If military, show rank, e.g. Doe, Maj. John E.) McTaggart, Kevin A.			
5. DATE OF PUBLICATION (month and year of publication of document) December 2011		6a. NO. OF PAGES (total including Annexes, Appendices, etc). 246	6b. NO. OF REFS (total cited in document) 27
7. DESCRIPTIVE NOTES (The category of the document, e.g. technical report, technical note or memorandum. If appropriate, enter the type of report, e.g. interim, progress, summary, annual or final.) Technical Memorandum			
8. SPONSORING ACTIVITY (the name of the department project office or laboratory sponsoring the research and development. Include address). Defence R&D Canada - Atlantic, PO Box 1012, Dartmouth, NS, Canada B2Y 3Z7			
9a. PROJECT OR GRANT NO. (If appropriate, the applicable research and development project or grant number under which the document was written.) 11ge01		9b. CONTRACT NO. (if appropriate, the applicable number under which the document was written).	
10a. ORIGINATOR'S DOCUMENT NUMBER (the official document number by which the document is identified by the originating activity. This number must be unique.) DRDC Atlantic TM 2011-307		10b. OTHER DOCUMENT NOS. (Any other numbers which may be assigned this document either by the originator or by the sponsor.)	
11. DOCUMENT AVAILABILITY (any limitations on further dissemination of the document, other than those imposed by security classification) (X) Unlimited distribution <input type="checkbox"/> Defence departments and defence contractors; further distribution only as approved <input type="checkbox"/> Defence departments and Canadian defence contractors; further distribution only as approved <input type="checkbox"/> Government departments and agencies; further distribution only as approved <input type="checkbox"/> Defence departments; further distribution only as approved <input type="checkbox"/> Other (please specify):			
12. DOCUMENT ANNOUNCEMENT (any limitation to the bibliographic announcement of this document. This will normally correspond to the Document Availability (11). However, where further distribution (beyond the audience specified in (11) is possible, a wider announcement audience may be selected).			

13. ABSTRACT (a brief and factual summary of the document. It may also appear elsewhere in the body of the document itself. It is highly desirable that the abstract of classified documents be unclassified. Each paragraph of the abstract shall begin with an indication of the security classification of the information in the paragraph (unless the document itself is unclassified) represented as (S), (C), (R), or (U). It is not necessary to include here abstracts in both official languages unless the text is bilingual).

ShipMo3D is an object-oriented library with associated user applications for predicting ship motions in calm water and in waves. This report serves as a user manual for creating ship models using ShipMo3D Version 3.0. A companion report serves as a user manual for predicting ship motions in the time and frequency domains. Version 3 of ShipMo3D introduces modelling of sloshing tanks and U-tube tanks. Several ShipMo3D applications are used for creating a ship. SM3DPanelHull creates a panelled representation of the wet and dry portions of the ship hull. SM3DRadDif computes radiation and diffraction forces acting on the wet hull using a boundary element method. SM3DPanelSloshTank creates a panelled representation of a sloshing tank, such as a tank containing liquid cargo or a roll stabilization tank. SM3DRadSloshTank computes sloshing forces arising from motions in the frequency domain. SM3DBuildShip creates a model of the ship that can be used for ship motion predictions in either the frequency domain or time domain.

14. KEYWORDS, DESCRIPTORS or IDENTIFIERS (technically meaningful terms or short phrases that characterize a document and could be helpful in cataloguing the document. They should be selected so that no security classification is required. Identifiers, such as equipment model designation, trade name, military project code name, geographic location may also be included. If possible keywords should be selected from a published thesaurus. e.g. Thesaurus of Engineering and Scientific Terms (TEST) and that thesaurus-identified. If it not possible to select indexing terms which are Unclassified, the classification of each should be indicated as with the title).

frequency domain
maneuvering
ship motions
simulation
time domain
waves